

KEYENCE



NEW PRODUCTS

LINE-UP CATALOGUE

TOTAL SENSING SOLUTION

FIBRE OPTIC



LASER SENSOR



SAFETY LIGHT CURTAIN

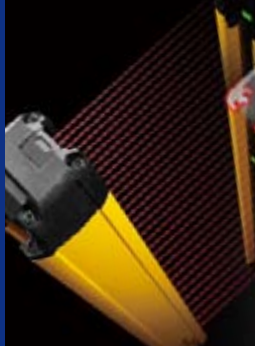

MEASUREMENT



VISION SYSTEM



MICROSCOPE

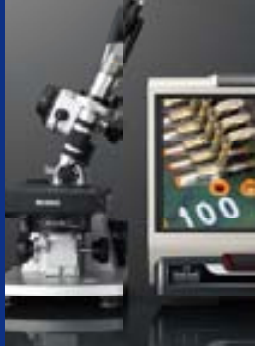

WHY IS KEYENCE UNIQUE?

Corporate Information

Global Headquarters: Osaka, Japan
 Founded: May 1974
 Capital: \$364,728,000 USD
 2011 Global Sales: \$2,373,023,000 USD
 Worldwide Employees: 3,420

Dollar amounts are translated from Japanese yen, for convenience only, at ¥84 = US\$1, the approximate exchange rate on March 20, 2012.

An Exceptional Company

KEYENCE has been named one of Business Week's "1000 Best Valued Companies" and consistently ranked ahead of companies such as Sony and Honda Motors in Japan's Nikkei, Tokyo Stock Exchange, Newspaper's ranking of the "Top Ten Excellent Companies in Japan."



KEYENCE Global Headquarters, Osaka, Japan

Exceptional Performance and results

Newsweek Electronics Industry Ranking

1	IBM
2	HP
3	CANON INC.
4	Panasonic
5	Apple INC.
6	ABB
7	DELL
8	Schneider Electric
9	Emerson Electric
10	Sony
⋮	
16	Xerox
⋮	
26	Seagate
⋮	
39	KEYENCE
⋮	
42	Rockwell Automation
⋮	

Nikkei Newspaper

KEYENCE consistently ranks in the "top ten" in the Nikkei newspaper's annual ranking of "excellent companies" in Japan.

- Maintains its ranking in top 30 (for 20 years)
- Ranked 1st twice (1995,1996)
- Ranked in the top 10 from 2005 to 2008

Recent Top 10

1	Nintendo
2	FANUC LTD.
3	Astellas Pharma Inc.
4	Takeda Pharmaceutical
5	KEYENCE
6	ROHM CO.,LTD.
7	CANON INC.
8	Trend Micro Inc.
9	TOYOTA Motor Corp
10	NTT DOCOMO,INC.

DEDICATED TO ADDING VALUE FOR OUR CUSTOMERS

Direct Sales

KEYENCE employs DIRECT Sales Engineers for product support and on-site consultation. We continually train our Sales Engineers on the latest sensing product technologies and applications to provide customers with the best solution for challenging sensing applications.

KEYENCE Direct Sales System

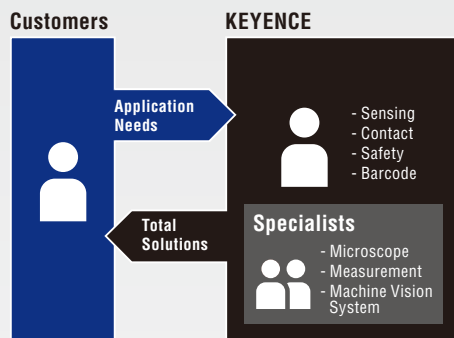

Conventional sales style

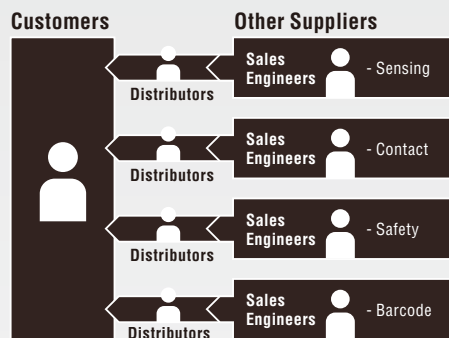

Same-Day Shipping

We offer same-day shipping in order to quickly deliver our products to our customers at the earliest possible date and can deliver even when they have unexpected on-site problems.



Comprehensive Support

KEYENCE provides reassuring post-sales support by offering product seminars, application guides, improvement proposals, and other follow-up services according to the needs and goals of our customers.



KEYENCE SENSORS CONTINUE TO IMPROVE



Digital Fibreoptic Sensor
FS-N Series

P. 6



Safety Light Curtain
GL-R Series

P. 10



Self-contained CMOS
Laser Sensor
LR-Z Series

P. 7

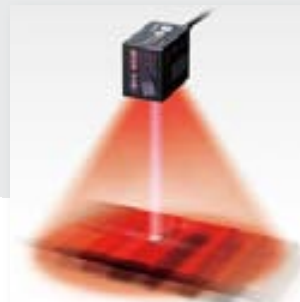

Ultra-Compact
1D/2D Code Reader/
Handheld 1D/2D Code
Reader
SR-600/HR Series

P. 12



CMOS Multi-Function
Analogue Laser Sensor
IL Series

P. 8



High-speed 2D/3D Laser
Scanner
LJ-V Series

P. 14



Multi-Purpose
CCD Laser Micrometer
IG Series

P. 9



High-speed
2D Measurement Sensor
TM Series

P. 16



Image Dimension
Measurement System
IM Series

P. 18



Easy Setup,
Auto-Teaching,
Machine Vision System
CV-X Series

P. 26



High-Precision
Digital Contact
Type Sensors
GT2 Series

P. 20



Ultra High-Speed,
High-Capacity
Multi-Camera Image
Processing System
XG Series

P. 28



Sheath-Sensing Ioniser
SJ-HA Series

P. 22



Digital Microscope
VHX-2000 Series

P. 30



Vision Sensor
IV Series

P. 24



High-speed Microscope
VW-9000 Series

P. 31

Digital Fibreoptic Sensor



Complete setting in just one click

An entirely new concept in setup ease. Just one click calibrates the sensitivity and resets the display.



High power reduces labour hours

Increased sensor power greatly reduces maintenance and setup time.



Automatic maintenance

The sensor automatically detects reduced light intensity due to debris build-up and automatically re-calibrates to the original display state.



LINEUP

Cable Type

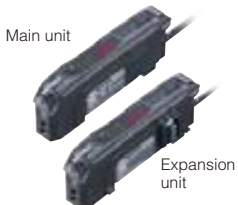

Type	Model	Model		Control outputs	External input	Analogue output
		NPN output	PNP output			
Standard	Main unit	FS-N11N	FS-N11P	1	0	0
	Expansion unit	FS-N12N	FS-N12P			
2-output	Main unit	FS-N13N	FS-N13P	2	1	
	Expansion unit	FS-N14N	FS-N14P			
Analogue	Main unit	FS-N11MN	—	1	0	1

Connector Type (M8)



Type	Model	Model		Control outputs	External input	Analogue output
		NPN output	PNP output			
Standard	Main unit	FS-N11CN	FS-N11CP	1	1	0
	Expansion unit	FS-N12CN	FS-N12CP			
2-output	Main unit	—	FS-N13CP	2	0	
	Expansion unit	—	FS-N14CP			

Self-contained CMOS Laser Sensor



BEST DETECTION ABILITY in its class

CMOS Laser + BGS + FGS



DURABLE & LONG LIFE

High enclosure rating and Stainless steel body (SUS316L)



SIMPLIFIED OPERATION

Large indicator and Digital display



APPLICATION

Black targets

Inspecting press fit anti vibration rubber bushings on an index table

350,000 fold power control enables reliable detection even on a black workpiece with low reflectivity.



Printed targets

Confirming package presence

The LR-Z Series performs reliable detection even on printed packaging with a glossy finish.



LINEUP

Type	Detecting distance	Spot diameter	Standard detectable deviation	Connection method	Output	Model	Weight
Rectangular w/ cable	35 to 100 mm	2 mm ±1 mm At detecting distance of 100 mm	1.5 mm (35 to 50 mm) 3 mm (50 to 100 mm)	2 m cable	NPN	LR-ZB100N	110 g
					PNP	LR-ZB100P	
Rectangular w/ M8 connector	35 to 100 mm	2 mm ±1 mm At detecting distance of 100 mm	1.5 mm (35 to 50 mm) 3 mm (50 to 100 mm)	M8 4-pin	NPN	LR-ZB100CN	55 g
				M8 3-pin	PNP	LR-ZB100CP LR-ZB100C3P	
Rectangular w/ cable	35 to 250 mm	2.4 mm ±1.2 mm At detecting distance of 250 mm	9 mm (35 to 180 mm) 25 mm (180 to 250 mm)	2 m cable	NPN	LR-ZB250N	110 g
					PNP	LR-ZB250P	
Rectangular w/ M8 connector	35 to 250 mm	2.4 mm ±1.2 mm At detecting distance of 250 mm	9 mm (35 to 180 mm) 25 mm (180 to 250 mm)	M8 4-pin	NPN	LR-ZB250CN	55 g
				M8 3-pin	PNP	LR-ZB250CP LR-ZB250C3P	

CMOS Multi-Function Analogue Laser Sensor



SCAN function with wide dynamic range

SCAN (=Sensitive-laser Control Analyser)

The laser power, shutter time and reception gain on this device are adjust in real-time in order to deliver stable detection faithfully for all targets. We also developed a new digital circuit that enables a dynamic range of x1.5 million, 2.5 times higher than past models. Real-time controls that suit targets and their surface conditions enable stable detection.

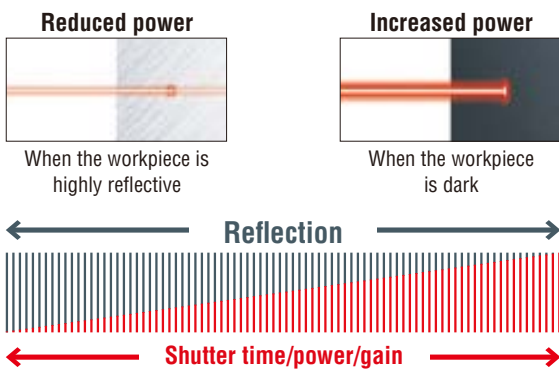

Sharp-Line Beam

KEYENCE's original optical system pushes the beam diameter to the limits (25 μm), and its sharpness enables the most excellent stability in history. We have overhauled and optimised our optical system for spot profiling for stability in applications that, until now, yielded very erratic results.

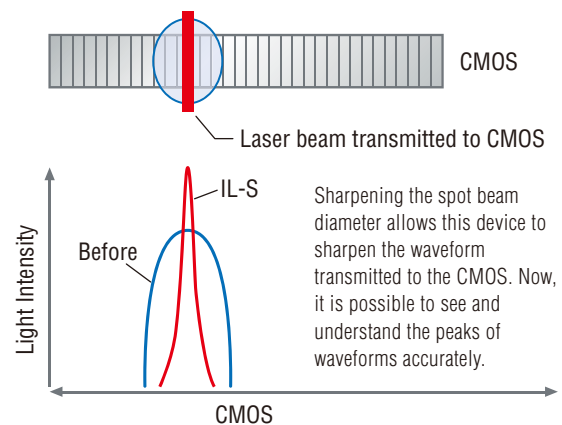

APPLICATIONS



Detecting welding seams



Control marking height

Multi-Purpose CCD Laser Micrometer



Extremely easy to use due to the built-in position monitor

The position monitor on the IG Series sensors makes it possible to visually check how a target is detected. The user can prevent mounting or setting errors by observing the red lights that indicate the received light position and the green lights that indicate the measurement position.

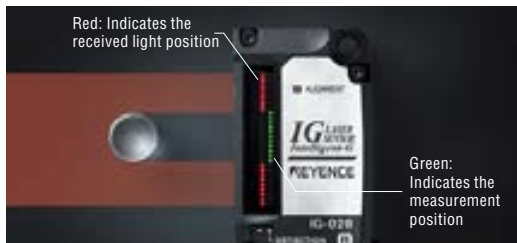

Easier optical axis alignment

The position monitor makes it easier to align the optical axis. Easily perform optical axis alignment by adjusting the sensor head so that all of the position monitor lights turn red.



Optical axis alignment in progress



Optical axis alignment complete

SPECIFICATIONS

Sensor heads

Model	IG-010	IG-028
Appearance		
Measurement range	10 mm	28 mm
Mounting distance	0 to 1000 mm	0 to 1500 mm
Repeatability	5 μm (Setting distance: 100 mm) 10 μm (Setting distance: 500 mm) 80 μm (Setting distance: 1000 mm)	5 μm (Setting distance: 100 mm) 10 μm (Setting distance: 500 mm) 80 μm (Setting distance: 1000 mm) 140 μm (Setting distance: 1500 mm)
Linearity	±0.28% of F.S. (±28 μm)	±0.1 % of F.S. (±28 μm)

Display unit (amplifier)

Model	IG-1000	IG-1500	IG-1050	IG-1550
Appearance				
Amplifier type	DIN rail mount	Panel mount	DIN rail mount	Panel mount
Main unit/Expansion unit	Main unit		Expansion unit	

Safety Light Curtain



STRONG

Built-in guarding and the narrowest exposed lens surface in the industry.

With its narrow (9 mm wide) and recessed lens surface, the GL-R Series is protected against impact and resultant damage from parts, tools or operators without the need for any additional guards or covers.

Additionally, the GL-R Series is protected from water and washdown environments due to its IP65/67 enclosure ratings.



SMART

No Dead Zone

Because the first beam is emitted 10 mm* from each end, the light curtain can be mounted flush inside of equipment, eliminating the need for additional guarding or outside mounting.

*Except GL-RL Series



7-segment display

If an error is ever detected by the light curtain, the 7-segment display provides a code that indicates the cause, which greatly reduces the time required to take corrective action.

SIMPLE



Reduce installation time with simple wiring and easy-to-use mounting brackets.

The introduction of the one-line wiring system and optical synchronisation simplifies connections to as few as 5 wires.

Mounting brackets come preassembled to provide simple, onestep installation.



Application

		
Detection capability: \varnothing 14 mm Beam axis pitch of \varnothing 10 mm. Entry detection	Detection capability: \varnothing 25 mm Beam axis pitch of \varnothing 20 mm. Entry detection	Detection capability: \varnothing 45 mm Beam axis pitch of \varnothing 40 mm. Entry/presence detection

SPECIFICATIONS

Model	GL-RF	GL-RH	GL-RL
Beam axis spacing/Lens diameter	10 mm / \varnothing 4	20 mm / \varnothing 5	40 mm / \varnothing 5
Detection capability	\varnothing 14 mm	\varnothing 25 mm	\varnothing 45 mm
Operating distance	0.2 to 10 m ^{*1}	0.2 to 15 m ^{*1}	
Effective aperture angle	Max. \pm 2.5° (When operating distance is 3 m or more)		
Light source	Infrared LED (870 nm)		
Response time	Optical synchronisation (Channel 0) or Wire synchronisation: 6.6 to 18.1 ms Optical synchronisation (Channel A or B): 6.9 to 27.4 ms		
OSSD operation	Turns on when no interruptions are present in the detection zone		
Synchronisation between the transmitter and receiver	Optical synchronisation or Wire synchronisation (Determined by wiring)		
Light interference prevention function	Prevents mutual interference in up to two GL-R systems. Optical synchronisation: prevented by Channel A and B with setting switch Wire synchronisation: prevented automatically		
Control output (OSSD output)	Output	2 transistor outputs. (PNP or NPN is determined by the cable type)	
	Max. load current	500 mA ^{*2}	
	Residual voltage (during ON)	Max. 2.5 V (with a cable length of 5 m)	
	OFF state voltage	Max. 2.0 V (with a cable length of 5 m)	
	Leakage current	Max. 200 μ A	
	Max. capacitive load	2.2 μ F	
Supplemental output (Non-safety-related output)	AUX	Transistor outputs (Compatible with both PNP and NPN)	
	Error output	Load current: Max. 50 mA, Residual voltage: Max. 2.5 V (with a cable length of 5 m)	
	Muting lamp output	Incandescent lamp (24 VDC, 1 to 5.5 W) LED lamp (load current: 10 to 230 mA) can be connected	
	EDM input		
External input	Wait input	[When using a PNP output cable] ON voltage: 10 to 30 V OFF voltage: Open or 0 to 3 V	[When using an NPN output cable] ON voltage: 0 to 3 V OFF voltage: Open or 10 V or more Up to the power voltage
	Reset input	Short circuit current: Approx. 2.5 mA (Approx. 10 mA with EDM input only)	
	Muting input 1, 2		
	Override input	Short circuit current: Approx. 2.5 mA (Approx. 10 mA with EDM input only)	
	Power supply	Voltage	24 VDC \pm 20%, ripple (P-P) 10% or less, Class 2
	Current consumption	Transmitter : 37 to 81mA, Receiver : 66 to 91 mA	
Protection circuit	Reverse current protection, short-circuit protection for each output, surge protection for each output		
Environmental resistance	Enclosure rating	IP65/IP67 (IEC60529)	
	Overvoltage category	II	
	Ambient temperature	-10 to +55°C (No freezing)	
	Storage ambient temperature	-25 to +60°C (No freezing)	
	Relative humidity	15 to 85% RH (No condensation)	
	Storage relative humidity	15 to 95% RH	
	Ambient light	Incandescent lamp: 3000 lux or less. Sunlight: 20000 lux or less	
	Vibration	10 to 55 Hz, 0.7 mm compound amplitude, 20 sweeps each in the X, Y and Z directions	
Shock	100m/S ² (approx. 10 G), 16 ms pulse in X, Y and Z directions, 1000 times each axis		
Material	Main unit case	Aluminium	
	Upper case/lower case	Nylon (GF 30%)	
	Front cover	Polycarbonate, SUS304	
Approved standards	EMC	EMS	IEC61496-1, EN61496-1, UL61496-1
		EMI	EN55011 ClassA, FCC Part15B ClassA, ICES-003 ClassA
	Safety		IEC61496-1, EN61496-1, UL61496-1 (Type 4 ESPE)
			IEC61496-2, EN61496-2, UL61496-2 (Type 4 AOPD)
			IEC61508, EN61508 (SIL3), IEC62061, EN62061 (SIL CL3)
			EN ISO13849-1:2008 (Category 4, PLc)
			UL508
	UL1998		

*1 When the option front protection cover is installed on the one of transmitter or receiver, the Operating distance is shortened by 0.5 m. When the front covers are installed on both of the transmitter and receiver, the Operating distance is shortened by 1.0 m.

*2 When the GL-R is used under surrounding air temperatures between 50 to 55°C, the Maximum load current should not exceed 350 mA.

Ultra-Compact 1D/2D Code Reader

Revolutionary technology enables high-accuracy measurement

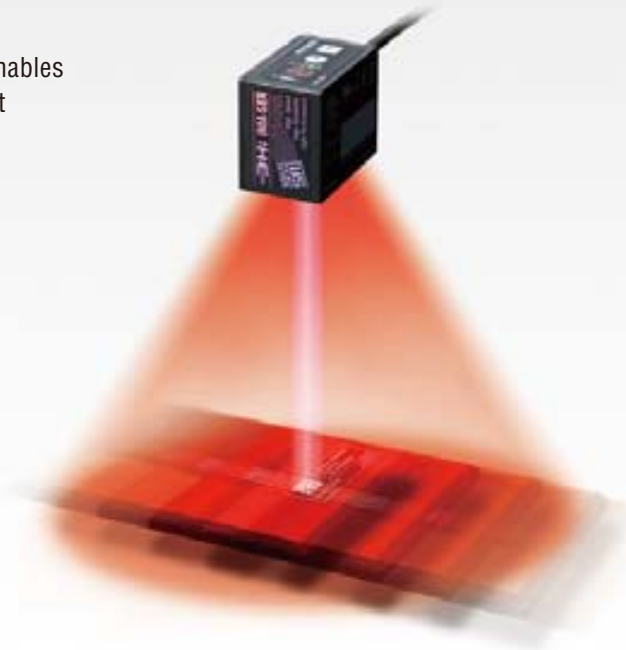

HI-SPEED

Reliable Moving Object Code Detection

Fastest in its class: New optical design with high-speed, high-sensitivity imaging allows the SR-600 Series to read codes moving as fast as 160 m/min.



HI-PERFORMANCE

Advanced Reading Flexibility

Simple setup with advanced reading ability. Up to 16 parameter banks allow greater flexibility when reading conditions change.



- Expansion/Shrink filter ... Reads dot printing
- Hi-DR Function ... Reduces glare and provides excellent contrast
- Parameter Bank & Alternate Function

HI-RELIABILITY

Easy Setup & Maintenance

Easy calibration can be performed by simply pressing the TUNE button. Built-in USB connectivity enables [Live] monitoring, testing, and function changes via the easy-to-use AutoID Navigator software.

2 EASY TUNING METHODS

1. TUNE button on the code reader



2. Quick setup using a laptop or PC

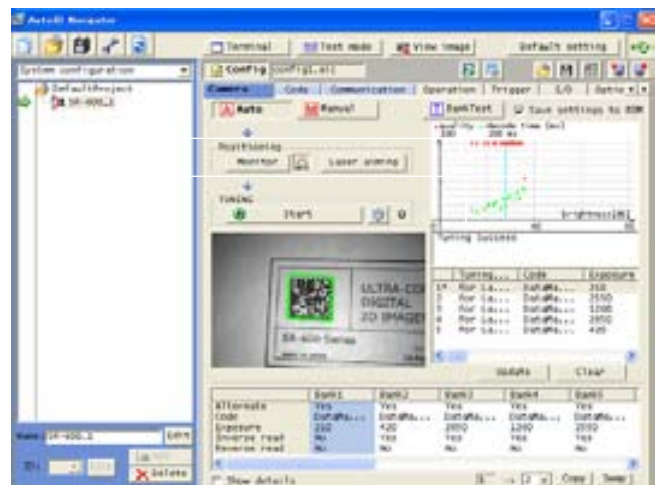

SPECIFICATIONS

Model		SR-600	SR-610	SR-600HA	
Type		Close-range type	Middle-range type	High-resolution type	
Laser pointer	Light source	Visible red semiconductor laser (wavelength: 660 nm)			
	Output	90 µW			
	Pulse duration	200 µs			
	Laser class	Class 1 Laser Product (IEC60825-1, FDA (CDRH) Part1040.10)*			
Illumination		High-intensity red LED			
Reading	Supported codes	Barcode	CODE39, ITF, Industrial2of5, COOP2of5, Codabar, CODE128, GS1-128, GS1 DataBar, CODE93, EAN/UPC, Trioptic Code39		
		2D code	QR, MicroQR, DataMatrix, PDF417, MicroPDF, MaxiCode, GS1 Composite		
	Focal distance	60 mm	100 mm	38 mm	
	Minimum resolution	Barcode	0.127 mm	0.127 mm	0.082 mm
		2D code	0.127 mm	0.25 mm	
	Reading time (representative example)		21 ms (Focal distance, in QR CODE 21 x 21)		
	Reading distance (representative example)	QR	31 mm to 97 mm (Cell size: 0.339 mm)	35 mm to 188 mm (Cell size: 0.508 mm)	17 mm to 54 mm (Cell size: 0.254 mm)
		DataMatrix	35 mm to 95 mm (Cell size: 0.339 mm)	40 mm to 173 mm (Cell size: 0.508 mm)	19 mm to 51 mm (Cell size: 0.254 mm)
		Barcode	29 mm to 106 mm (Narrow bar width: 0.339 mm)	44 mm to 205 mm (Narrow bar width: 0.508 mm)	
	Reading view range (focal distance)		42.5 mm x 27.1 mm	70.6 mm x 45.0 mm	26.6 mm x 17.0 mm
I/O	Input terminal		2 inputs (IN1, IN2), non-voltage input (relay contact, solid state)		
	Control output		NPN open-collector output: 4 outputs (OUT1 to OUT4) 30 mA max. (24 V max.) Residual voltage 0.8 V max., leakage current 0.1 mA max.		
	RS-232C	Communication method		Conforms to RS-232C	
		Communication speed		9600/19200/38400/57600/115200 bps	
		Synchronous method		Start-stop Synchronisation	
		Data length		7/8 bits	
		Stop bit length		1/2 bits	
	Parity check		None/Even/Odd		
USB		Conforms to USB 2.0 Full Speed			
Environmental resistance	Enclosure rating		IP65		
	Operating ambient temperature		0 to 45 °C		
	Storage ambient temperature		-10 to +50 °C, No condensation		
	Operating ambient humidity		35 to 95%RH, No condensation		
	Ambient operating illuminance		Sunlight: 10000 lux, Incandescent lamp: 6000 lux, Fluorescent lamp: 2000 lux		
	Operating atmosphere		No dust or corrosive gas present		
Vibration resistance		10 to 55 Hz, 1.5 mm double amplitude in X, Y, and Z directions, 3 hours respectively			
Rating	Power voltage		5 VDC +5%,-10%		
	Consumption current		630 mA max		
Weight		Approx. 160 g (including the cable)/Weight without cable: Approx. 27 g			

* The laser classification for FDA (CDRH) is implemented based on IEC60825-1 in accordance with the requirements of Laser Notice No.50.

* Use the Limited Power Source defined in UL/IEC60950-1 to comply with UL/IEC60950-1.

Handheld 1D/2D Code Reader

HR SERIES



Easy Code Capture Allows High Speed Reading

WIDE READING AREA & FASTER READING SPEED

Thanks to a wide reading area and deep depth of view, codes are easily captured at the pull of the trigger.

Furthermore, high-speed reading that was not available with conventional handheld readers is now possible.

High-speed 2D/3D Laser Scanner



Ultra-high-speed/Ultra stability

What is a laser measuring device that is truly useful inline?

“Improved quality”, “defect outflow prevention”, “increased yield”
Calls and complaints from customers regarding manufacturing issues continue to increase on a daily basis, causing the level of demand for these items to increase.

KEYENCE's new proposal is the LJ-V7000 Series, an ultra-high-speed inline profile measuring device that implements ultimate quality control to “measure any product of any shape ‘with extreme detail’.”

World's fastest 240 times greater than conventional devices

64.000 profiles/sec. sampling 12.800.000 points/sec.

The LJ-V7000 Series has achieved the world's fastest sampling speed. Other devices within the 2D laser measuring device market cannot even come close. It can measure the shapes of products running on a line or through equipment at ultra high speeds, with high-resolution and without missing an item. As an example, it can measure targets moving at 6.4 m/s with a pitch of 0.1 mm. The LJ-V7000 Series does not allow the passing of abnormal or defective areas.



Industry's greatest 64 times the dynamic range of conventional devices

Overwhelming workpiece response capabilities and detection stability

Normally, detection stability is inversely proportional to speed. However, the LJ-V7000 Series has achieved the improvements in both speed and detection stability. Shapes are accurately measured even in cases where black surfaces or inclines with low reflectivity and metallic surfaces with high reflectivity are mixed together under the same optical axis.



APPLICATIONS



Measuring loose bearing seals

Bearings are rotated to detect loose seals and perform a variety of measurements. High-speed measurement is possible, and in addition to bearings, the completion time to inspect shapes for rotating objects is also greatly improved.



Measuring welding grooves and bead shapes

Welding grooves and bead shapes are measured. Can be used on site without worry due to its strong IP67 structure, shock resistance, and high-flex cable.



Measuring the swelling of steel sheets

The shapes of continuous swelling on steel sheets that are flowing at high-speeds are measured. Because it is possible to measure at speeds of up to 64 kHz, you can perform high-definition measurement at fine pitches.



Measuring the shapes of projections and depressions on extrusion moulded products

Measurement is performed to determine if the shapes of moulded parts that are extruded at high speeds are correct or not. Various targets can be supported, including rubber, metal, ceramics, concrete, and food products.

SPECIFICATIONS

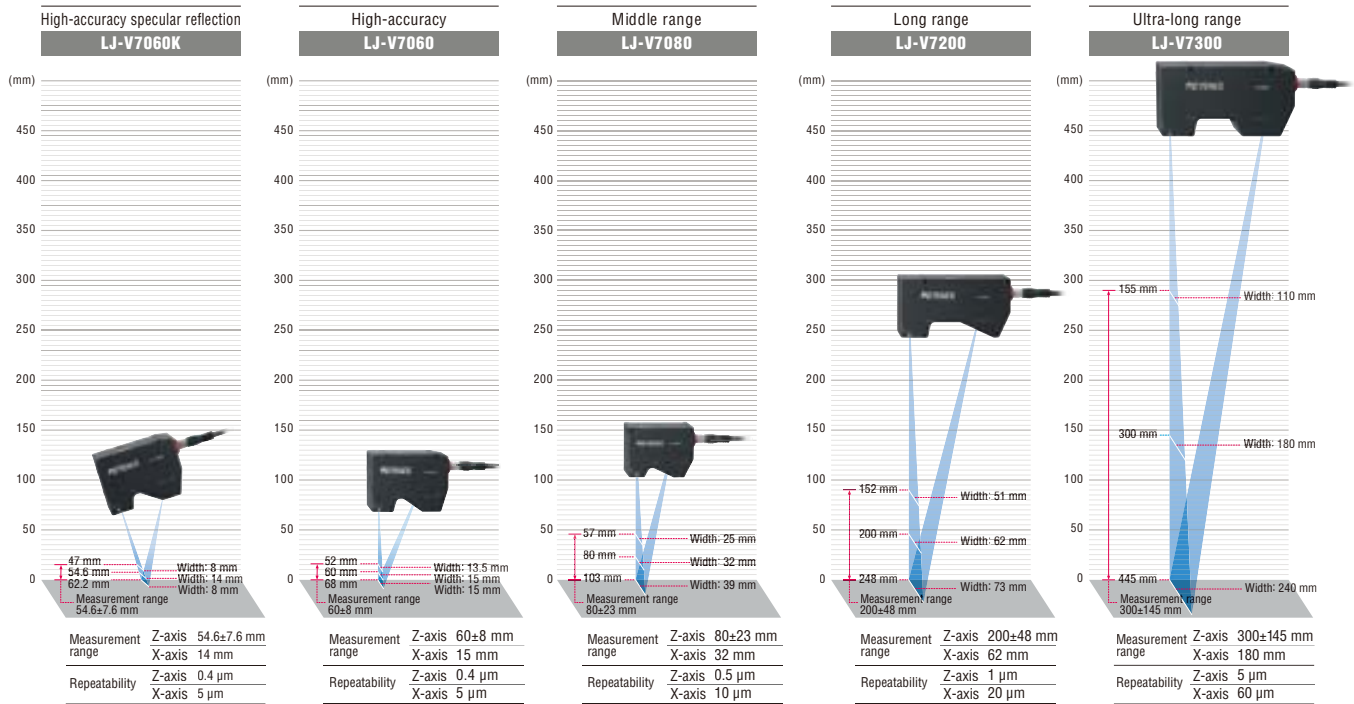

Controller



Controller
LJ-V7001(P)
Controller variation
NPN output type **LJ-V7001**
PNP output type **LJ-V7001P**



Settings monitor software
LJ-H2



Display output unit
LJ-VM100

Console
OP-87504



Monitor

Touch panel monitor
CA-MP120T



Specialised monitor stand
OP-87262



Cable connector

Head connection cable
CB-B3 (3 m) / CB-B10 (10 m)



Display monitor connection cable
OP-66842 (3 m) / OP-87055 (10 m)



Head connection extension cable
CB-B5E (5 m) / CB-B10E (10 m) / CB-B20E (20 m)



RS-232C cable
OP-96368 (2.5 m)



Touch panel monitor extension cable
OP-87258 (3 m) / OP-87259 (10 m)



D-sub 9 pin connector
OP-26401



High-speed 2D Measurement Sensor



Because the TM-3000 is 2D it can...

Measure single point and edge dimensions

No need to position an object, outer diameter and angles can be measured instantaneously. In addition, since the object position is recognised, accurate measurement is performed with position correction. Furthermore, variations due to surface roughness of an object are suppressed with edge averaging, improving the reliability of measurement.

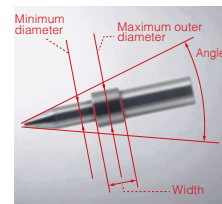

High speed production support

Newly developed HT processor

Newly developed high speed 2D dedicated includes a high-speed computing CPU and two dedicated image processing DSPs. Using a total of four processors for parallel processing, TM-3000 Series allows for fast processing of 1800(images)/minute.

*HT Processor...High Speed Two Dimensional Processor

*1800 images/min... calculated with approx. 33 ms trigger interval (default setting)



High precision inspection

A high brightness LED and a double telecentric optical system ensure high precision performance

A advantage of the thrubeam type which is not affected by external lighting, $\pm 0.15 \mu\text{m}$ repeatability.

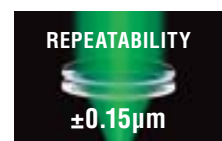

APPLICATIONS

Unit: mm

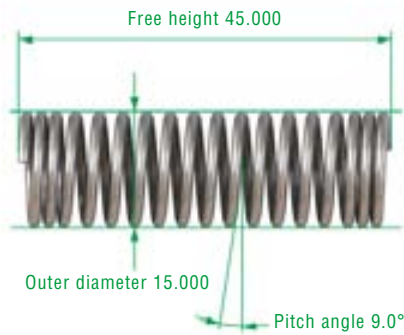

Measures outer diameter /pitch angel of springs

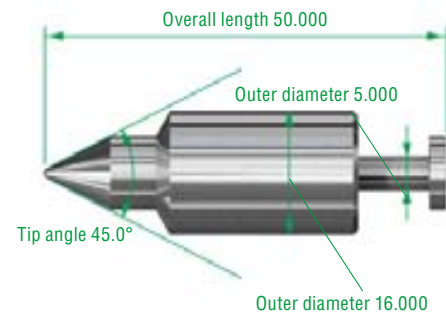

Measures outer diameter/tip angle of needle valves

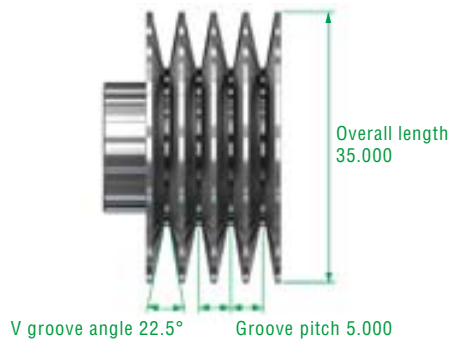

Measures pulley groove pitches/V groove angles

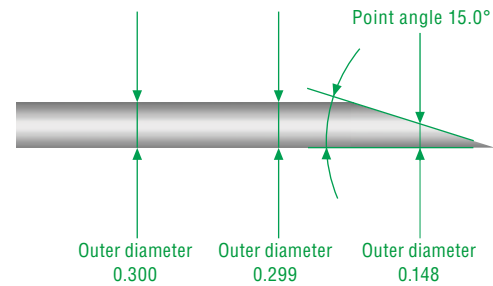

Measures multi-point outer diameter/point angle of injection needles

SPECIFICATIONS (SENSOR HEAD)

Model	TM-006	TM-040	TM-065	
Measuring range	ø6 mm	ø40 mm	ø65 mm	
Smallest detectable object	0.04 mm	0.3 mm	0.5 mm	
Transmitter/receiver distance	60 mm	180 mm	270 mm	
Light source	GaN Green LED	InGaN Green LED		
Measurement accuracy	±0.5 μm ^{*1}	±2 μm ^{*3}	±3 μm ^{*5}	
Repeatability	±0.06 μm ^{*2}	±0.15 μm ^{*4}	±0.2 μm ^{*6}	
Sampling cycle (trigger interval) ^{*7}	5.5ms (33ms at the initial setting)			
Environmental resistance	Enclosure rating ^{*8}	IP64		
	Ambient temperature	0 to 50°C		
	Relative humidity	35 to 85% (No condensation)		
Material	Aluminium			
Weight	Transmitter	Approx. 140g	Approx. 560g	Approx. 1280g
	Receiver	Approx. 340g	Approx. 720g	Approx. 1460g
	Base	Approx. 220g	Approx. 630g	Approx. 1500g

*1 In a measurement area of 2 mm×ø4 mm error when measuring width of KEYENCE standard object (glass calibration scale).

*2 Value of ±2σ measuring the width of KEYENCE standard object (glass calibration scale) in the centre of the measurement area, an average 16 times, average 1.3 mm line.

*3 In a measurement area of 10 mm×ø26 mm error when measuring width of KEYENCE standard object (glass calibration scale).

*4 Value of ±2σ measuring the width of KEYENCE standard object (glass calibration scale) in the centre of the measurement area, an average 16 times, average 8 mm line.

*5 Error when measuring width of KEYENCE standard object (glass calibration scale) in a measurement area of 20 mm×ø40 mm.

*6 Value of ±2σ measuring the width of KEYENCE standard object (glass calibration scale) in the centre of the measurement area, an average 16 times, average 14 mm line.

*7 When measurement area is minimum, others are initial settings

*8 Apart from connector component

Image Dimension Measurement System



Drastically Reduced Measurement Time

Just place and press: 99 features are measured in seconds.

Just place a target and press the button. Ninety-nine points are measured in seconds. The system automatically finds and measures targets even when they are placed in a different location or orientation, which significantly reduces measurement time.



Eliminating Individual Differences

High-precision automatic measurement using the latest image processing technology

Since the shape of a target is automatically recognised before measurement, the result is not affected by individual differences such as alignment errors or variations in the skill level of equipment users. The same results can be obtained consistently no matter who is taking the measurements.

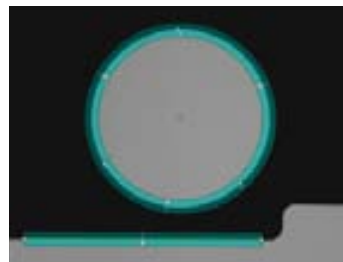

Easy Setup for Wider Applications

Easy setup by checking the entire image of a target

Even the initial setup is easy, just specify points with the mouse while checking the entire image of a target. You can easily complete the setup procedure for a wider range of measurements from outer diameter, circular pitch, and angle measurements to measurements using virtual lines or points.

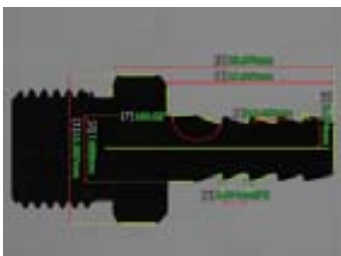

Easy Data Management

Statistics/analysis function for easy trend checking or reporting

All measurement results will be saved automatically. The included statistics/analysis function allows easy checking of the points for improvement and preparation of inspection records. Of course, measurement data can be imported to and used on spreadsheet software.



APPLICATIONS

Model	Controller	IM-6500E	
		IM-6010	IM-6020
Image pickup device	Head	1* 6.6 mega pixel CMOS	
Display		10.4" LCD monitor (XGA: 1024 x 768)	
Light receiving lens		Double telecentric lens	
Field of view	Wide-field measurement mode	ø100 mm	ø100 mm
	High-precision measurement mode	—	ø25 mm
Minimum display unit		0.1 µm	
Repetition Accuracy	Wide-field measurement mode	±1 µm	±1 µm
	High-precision measurement mode	—	±0.5 µm
Measurement accuracy	Wide-field measurement mode	±5 µm ¹	±5 µm ¹
	High-precision measurement mode	—	±2 µm ²
External remote input		No-voltage input (with and without contact)	
External output	Comparator output (OK/NG/FAIL)	Relay output/rated load: 24 VDC 0.5A/ON resistance: 50 mΩ or less	
Interface	LAN	RJ-45 (10BASE-T/100BASE-TX/1000BASE-T)	
	USB 2.0 series A	6 ports (Front: 2, Rear: 4)	
Record	Hard disk drive	160 GB	
Resistance to environment	Operating ambient temperature	+10 to 35°C	
	Operating ambient humidity	20% to 80% RH (no condensation)	
Illumination system	Coaxial transparent illumination	Telecentric transparent illumination (green LED)	
	Ring epi-illumination	Four division ring illumination (white LED)	
Z-axis stage	Moving range along Z axis	30 mm	
	Withstand load	3 kg	
Power supply	Power supply voltage	100 to 240 VAC 50/60 Hz	
	Power consumption	180 VA max.	
Weight	Controller	Approx. 8 kg	
	Head	Approx. 24 kg	Approx. 25 kg

*1 ±2σ in the range of ø80 mm from the centre of the stage at the operating temperature range of +23±1.0°C degrees at the focused focal point position

*2 ±2σ in the range of ø20 mm from the centre of the stage at the operating temperature range of +23±1.0°C degrees at the focused focal point position

DIMENSIONS

Head
IM-6010/6020

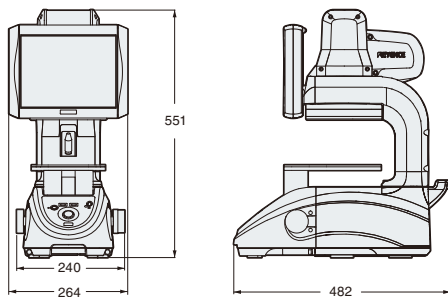

Controller
IM-6500E

Unit:mm

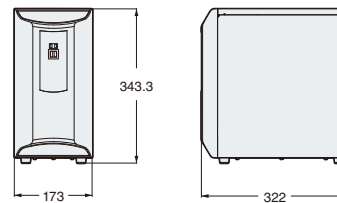

High-Precision Digital Contact Type Sensors

Revolutionary technology enables high-accuracy measurement



GT2 Air Push Type



Air push models for stable operation with easy mounting.

High-precision detection using absolute method with 0.1 μm resolution and 1 μm accuracy

The absolute method can eliminate count skip and speed errors, ensuring the highest accuracy in its class (Resolution: 0.1 μm, Accuracy: 1 μm).

Rigid structure

Detecting durability: 30 million times

Contact type sensors cannot avoid damage due to friction during long-term use. The GT2 Series uses linear ball bearings that extend the service life to withstand 30 million detections.*

*GT2-H12 (L/K/KL), typical

IP67 enclosure rating*

The GT2 Series (including the connector) meets the requirements of the IP67 enclosure rating under IEC/JIS. Since the GT2 Series is resistant to harsh environments, it can withstand long-term use. * Except for low measurement force type

Free-cut flexible cable

The sensor head cable is a robot cable which is resistant to continuous bending motions. It can withstand 20 million bending motions.

Withstands bending 20 million times without breaking (Typical usage)

Load (W): 250 g

Bend radius: 50 mm

Bending rate: 30 times/minute (1 time includes left to right to original position)

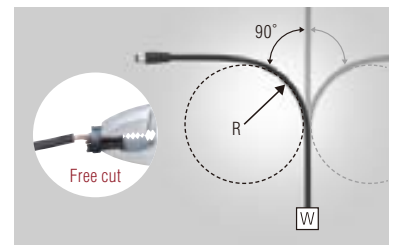
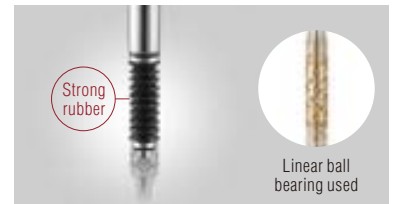

GT2 Air push type

Standard type

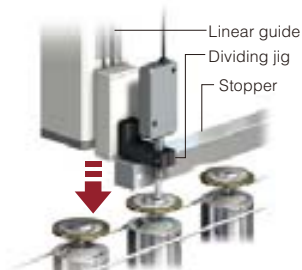







Air push type

A complex jig is not necessary since there is no sensor head movement. In addition, errors in accuracy due to jigs have been eliminated.

All jigs unnecessary.









Sensor heads for the GT2 Standard Type

Model	GT2-H12K	GT2-H12KL	GT2-H12	GT2-H12L	GT2-H32	GT2-H32L	GT2-H50	
Type	Standard/Low stress (L) type (Sensor head for 12 mm)				Standard/Low stress (L) type (Sensor head for 32 mm/50 mm range)			
Appearance								
Detection system	Quartz glass scale, CMOS image sensor projection system, Absolute type (without tracking error)							
Measuring range	12 mm				32 mm		50 mm	
Resolution	0.1 µm				0.5 µm			
Accuracy (20°C)	1 µm (p-p)		2 µm (p-p)		3 µm (p-p)		3.5 µm (p-p)	
Measuring force ^{*1}	Downward mounting	1.0 N	0.4 N	1.0 N	0.4 N	2.1 N	1.2 N	3.2 N
	Side mounting	0.9 N	0.3 N	0.9 N	0.3 N	1.8 N	0.9 N	2.8 N
	Upward mounting	0.8 N	0.2 N	0.8 N	0.2 N	1.5 N	0.6 N	2.4 N
Mechanical response	10 Hz		4 Hz		6 Hz		5 Hz	7 Hz
Probe	Carbide ball ø3			Steel ball ø3				
Operation indicator	2-colour LED (red, green)							
Environmental resistance	Enclosure rating	IP67	–	IP67	–	IP67	–	IP67
	Ambient temperature	-10 to +55°C						
	Relative humidity	35 to 85% RH (No condensation)						
	Vibration	10 to 55 Hz, 1.5 mm, double amplitude, 2 hours in each of X, Y, and Z directions						
Sensor head cable	Optional (M8 connector)							
Materials	Main body	Main body cast: Zinc die-casting, Indicator: Polyarylate, Dust boot: NBR ^{*2}						
	Contact	TYPE304 Stainless steel, super-tough tungsten alloy		TYPE304, 440C Stainless steel				
Weight (excluding cable)	Approx. 95 g				Approx. 270 g		Approx. 320 g	
Accessories	Refer to the instruction manual.							

*1 Value at centre of measuring range.

*2 A dust boot is not provided with the GT2-H12KL, the GT2-H12L or the GT2-H32L.

Sensor heads for the GT2 Air Push Type

Model	GT2-A12K	GT2-A12KL	GT2-A12	GT2-A12L	GT2-A32	GT2-A50	
Type	Standard / Low stress (L) type (Sensor head for 12 mm)				Standard type (Sensor head for 32 mm/50 mm range)		
Appearance							
Detection system	Quartz glass scale, CMOS image sensor projection system, Absolute type (without tracking error)						
Measuring range	12 mm				32 mm		50 mm
Resolution	0.1 µm				0.5 µm		
Accuracy (20°C) ^{*1}	1 µm (p-p)		2 µm (p-p)		3 µm (p-p)		3.5 µm (p-p)
Measuring force ^{*2}	Downward mounting	1.2 N	0.4 N	1.2 N	0.4 N	2.1 N	3.2 N
	Side mounting	1.1 N	0.3 N	1.1 N	0.3 N	1.8 N	2.8 N
	Upward mounting	1.0 N	0.2 N	1.0 N	0.2 N	1.5 N	2.4 N
Operation indicator	2-colour LED (red, green)						
Applied pressure range	0.25 to 0.5 MPa						
Pressure resistance	1.0 MPa						
Environmental resistance	Enclosure rating	IP67 ^{*3}	–	IP67 ^{*3}	–	IP67 ^{*3}	IP67 ^{*3}
	Ambient temperature	0 to 55°C					
	Relative humidity	35 to 85% RH (No condensation)					
	Vibration ^{*4}	10 to 55 Hz, 1.5 mm, double amplitude, 2 hours in each of X, Y, and Z directions					
Sensor head cable	Optional (M8 connector)						
Materials	Main body	Main body case: Zinc die-casting; Cylinder part: Aluminium alloy; Air joint resin part: Polyacetal; Air joint metal part: Brass nickel plating; Indicator: Polyarylate					
	Dust boot	NBR	–	NBR	–	NBR	NBR
	Contact ^{*5}	TYPE304 Stainless steel, super-tough tungsten alloy		TYPE304, 440C Stainless steel			
Weight (excluding cable)	Approx. 145 g				Approx. 340 g		Approx. 405 g
Accessories	Refer to the instruction manual.						

*1 Value when ambient temperature is 20°C

*2 Value at centre of measuring range. Please note that the measurement force changes depending on the installation state of the dust boots.

*3 Make sure the air tube is connected to the air exhaust joint and that no foreign materials enter inside from the joint.

*4 In the case where a mounting bracket D is used with GT2-A32 and GT2-A50, the double amplitude becomes 0.75 mm.

*5 The contact is included with the sensor.

Sheath-Sensing Ioniser



Double Hole Electrode Probe

Newly-developed

In addition to the sheath air guiding structure to minimise dust adhesion, the double hole electrode probe cap is used for the main electrode probes, which issues jets of air from the two holes. This ensures high-speed static elimination while maintaining laminar flows.

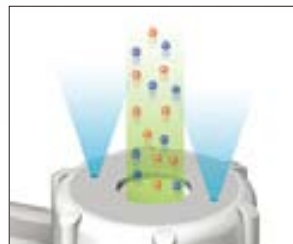

Maintenance-saving

5 times less maintenance than conventional models

The sheath air guiding structure which prevents dust adhesion on electrode probes is used for the main electrode probes. By supplying clean and dry air, the system maintains the cleanliness of the electrode probes regardless of the surrounding environment. This ensures an extraordinary maintenance-saving effect. The number of maintenance steps can be greatly reduced.

* Comparison with a conventional model (SJ-G)

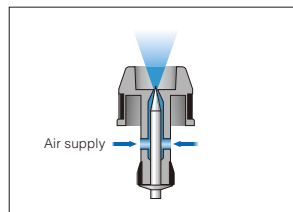

Conventional model
 (Cross-sectional view of the electric probe cap)

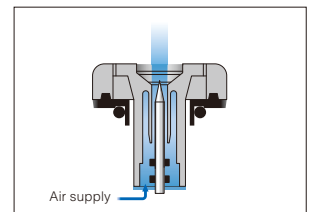

Sheath air guiding structure
 (Cross-sectional view of the electric probe cap)

The use of high-density tungsten reduces probe wear and tear

After thorough review of the grain density of the tungsten probe, we succeeded in maximising ion generation as well as reducing the ratio of sudden chipping during maintenance. This reduces the number of maintenance steps while improving the static elimination capacity.



Grain density: High

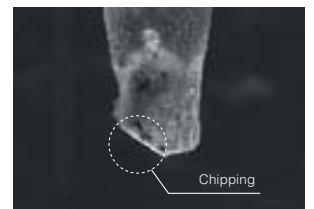

Grain density: Low

* Conditions: The electrode probe has been cleaned with alcohol after two month of use.

Low-voltage 24 V wiring

Low-voltage 24 V wiring eliminates the adverse effect of discharge on cabling and surrounding equipment, allowing the construction of a highly reliable system.

Indicators and outputs featured as standard

Safety functions, including the low-voltage 24 V wiring, abnormal discharge detection output, electrostatic charge monitor, and ion level alarm are featured as standard.

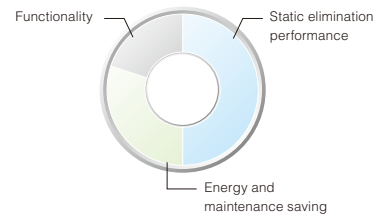
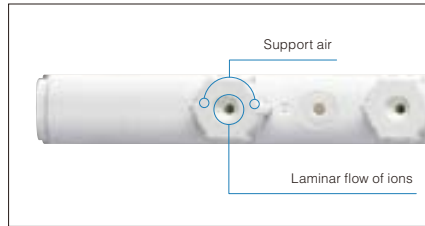
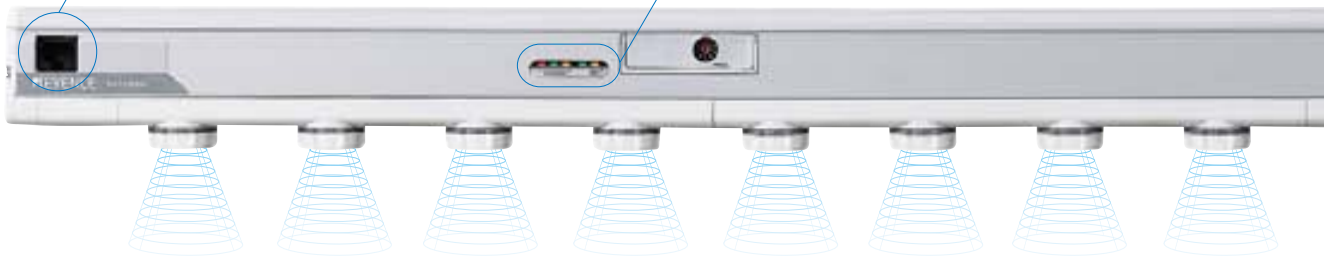

SPECIFICATIONS

Model	SJ-H036A	SJ-H060A	SJ-H084A	SJ-H108A	SJ-H132A	SJ-H156A	SJ-H180A	SJ-H204A	SJ-H228A	SJ-H252A	SJ-H300A	
Ion generation method	Corona discharge method											
Structure	Shock-proof, resistance-coupled type											
Voltage application method/applied voltage	Pulse AC method/±7000 V											
Ion balance control method	Dual I.C.C. method											
Ion balance ^{*1}	±30 V											
Operating distance	50 to 2000 mm											
Control input	NPN open collector or non-voltage contact signal											
Control output	NPN type photo-relay, 100 mA max. (40 V max.)											
Ratings	Power supply voltage	24 VDC-36 V ±10%										
	Current consumption	560 mA (at 24 VDC) / 400 mA (at 36 VDC)										
	Overtoltage category	I										
	Pollution degree	2										
Primary features	Condition alarm, ion level alarm, alarm output											
Air purge connection port	Rc 1/8											
Air purge air supply pressure	0.5 MPa or less											
Materials	Electrode probe	Tungsten										
	Body	ABS resin/PC										
Environmental resistance	Ambient temperature	0 to +40°C										
	Relative humidity	35 to 85%RH (No condensation)										
Effective length ^{*2}	360 mm	600 mm	840 mm	1080 mm	1320 mm	1560 mm	1800 mm	2040 mm	2280 mm	2520 mm	3000 mm	
Total length (A) ^{*3}	380 mm	600 mm	840 mm	1080 mm	1320 mm	1560 mm	1800 mm	2040 mm	2280 mm	2520 mm	3000 mm	
Weight	Controller	150 g	-	-	-	-	-	-	-	-	-	
	Static elimination bar	500 g	780 g	980 g	1200 g	1400 g	1550 g	1750 g	2000 g	2350 g	3150 g	

*1. Measurement value under the following conditions:

Operating distance	300 mm (22 Hz)	600 mm (10 Hz)	1500 mm (1 Hz)
Operating ambient temperature	0 to +40°C		
Operating ambient humidity	35 to 65%RH		

Under a 0.3 m/s downflow

*2. The effective length is determined based on the static elimination range at a distance of 50 mm.

*3. The total length includes the end units.

Vision Sensor



Automatic focus

Focusing, which used to be a manual process, is now done automatically in the IV Series. One-touch quick focusing is done by a unique automatic focus motor developed exclusively for the IV Series.

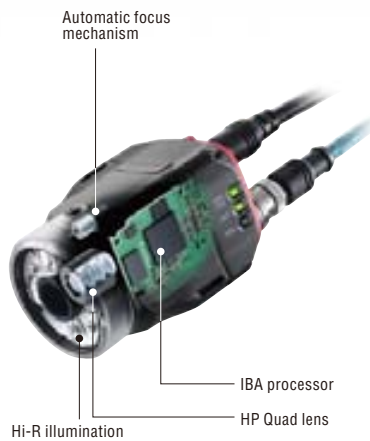

Automated, one-touch brightness adjustment

Gain, exposure time, and illumination are adjusted automatically, and operations are completed with one-touch controls. As anyone can now shoot clear detection images, there are fewer variations due to differing imaging skills.

Easy navigation

Simply follow the setup flow from “single touch imaging” to output setup. The intuitive touch screen operation allows startup to be completed in about one minute, without the need for referring to manuals.

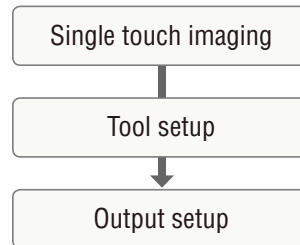

SENSOR LINEUP

Close range sensor model

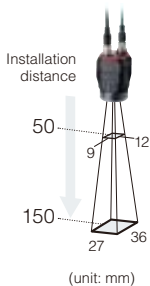

Monochrome AF type
IV-150MA
Monochrome MF type
IV-150M

Standard sensor model

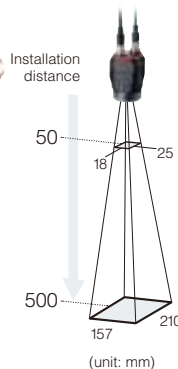

Colour AF type
IV-500CA
Colour MF type
IV-500C
Monochrome AF type
IV-500MA
Monochrome MF type
IV-500M

Long range sensor model

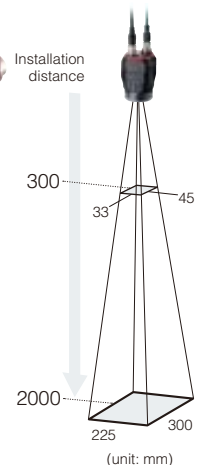

Monochrome AF type
IV-2000MA
Monochrome MF type
IV-2000M

AF...Automatic focus model
MF...Manual focus model

* View and optical axis has individual differences.
*The field of vision is halved when the digital zoom function (monochrome type only) is used.

APPLICATIONS

Presence detection and direction detection for electrical components

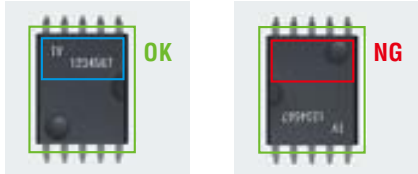

Detects the direction of the IC in carrier tape

Using the position adjustment tool, stable detection can be achieved even when work has moved in the carrier tape. High speed adjustment enables detection without slowing down the processing time of the unit.

Print presence

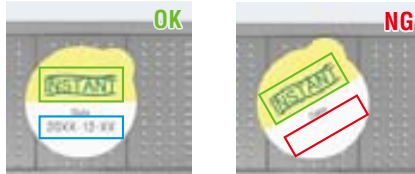

Detects the presence of printing

The 360° rotary position compensation function enables stable detection, regardless of cup orientation.

Product assembly check



Detects the presence of packing in metallic parts

A combination of HS-HDR and a colour camera enables stable detection for metal works with uneven reflection.

SYSTEM CONFIGURATION

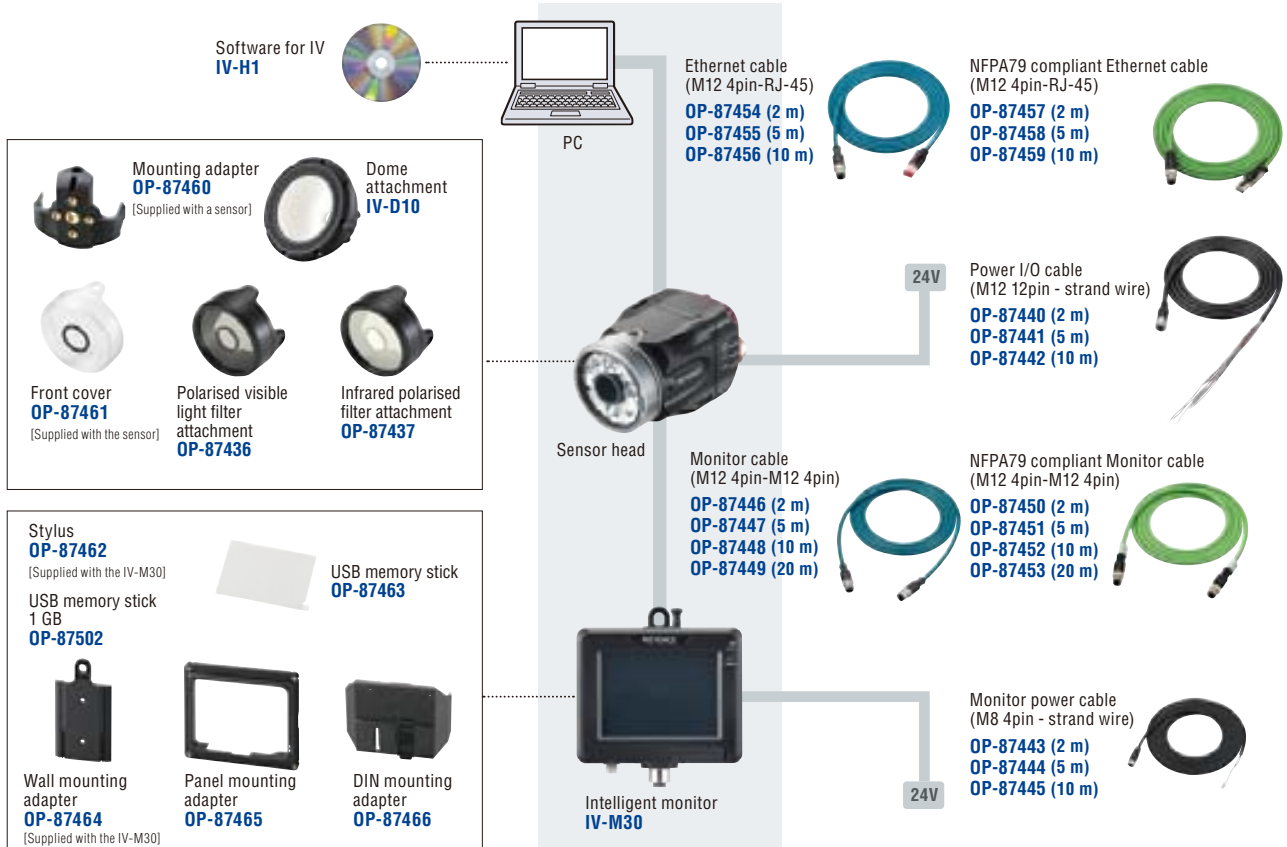

Easy Setup, Auto-Teaching, Machine Vision System



Auto-Teach Inspection

Human-like sense of judgement

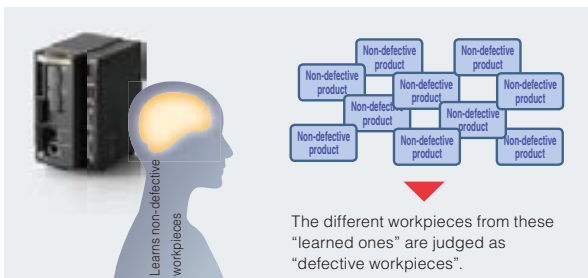

The image sensor auto-teaches variations such as product colour and individual differences that exist in the non-defective workpieces. "Auto-Teach Inspection" is a thinking tool which recognises the similarity with the non-defective workpieces instead of detecting the defective one. This feature eliminates the conventional unstable factors.

Utilities

Professional knowledge adjustments incorporated into utilities

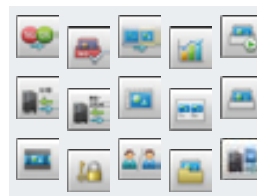

"Adjustment Navigation" is for false positive correction, and "Camera Installation Replication" for the horizontal deployment of the line. Those make the professional adjustment know-how into utilities.

User Manual Auto-Generation

A single button click to create customised user manual based on applied settings



It is possible to create a dedicated manual according to the settings with a single button. This feature supports the operation after introduction, the most important for the image processing.

APPLICATIONS

IC presence inspection in carrier tape



Lead defective inspection for capacitor

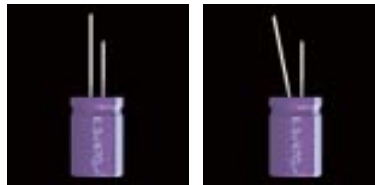

LED appearance inspection

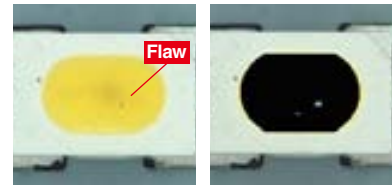

Type discrimination for wheels



Text recognition of best before date



Bent inspection for IC leads

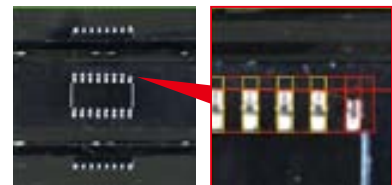

CONTROLLER

Supports 5 megapixel cameras
Ultra high-speed, high-capacity type
CV-X170



Supports 2 megapixel cameras
High-speed type
CV-X150



For 310,000 pixels only
CV-X100



CAMERA LINEUP

	5 megapixel camera series		2 megapixel camera series				1 megapixel camera series		310,000 pixels camera series		
	11x 5MEGA DIGITAL		7x MEGA DIGITAL	MEGA DIGITAL	SUPER-SMALL DIGITAL		7x MEGA DIGITAL	7x HI-SPEED DIGITAL	HI-SPEED DIGITAL	ULTRA-SMALL DIGITAL	
Model	CV-H500M CV-H500C		CV-H200M CV-H200C	CV-200M CV-200C	CV-S200M CV-S200C		CV-H100M CV-H100C	CV-H035M CV-H035C	CV-035M CV-035C	CV-S035M CV-S035C	
Specs	11x Monochrome 11x Colour		7x Monochrome 7x Colour	Monochrome Colour	Compact monochrome Compact colour		7x Monochrome 7x Colour	7x Monochrome 7x Colour	Monochrome Colour	Compact monochrome Compact colour	
Capture range	2432 x 2050 pixels 2432 x 2050 pixels		1600 x 1200 pixels 1600 x 1200 pixels	1600 x 1200 pixels 1600 x 1200 pixels	1600 x 1200 pixels 1600 x 1200 pixels		1000 x 1000 pixels 1000 x 1000 pixels	640 x 480 pixels 640 x 480 pixels	640 x 480 pixels 640 x 480 pixels	640 x 480 pixels 640 x 480 pixels	
Transfer time	61.2 ms 61.2 ms		29.2 ms 29.2 ms	59 ms 59 ms	59 ms 59 ms		20.5 ms 20.5 ms	4.7 ms 4.7 ms	16.7 ms 16.7 ms	16.7 ms 16.7 ms	

Ultra High-Speed, High-Capacity Multi-Camera Image Processing System



A 2-way processor structure that responds to the situation

- Integrated development environment VisionEditor
- Controller flow editing



A rich variety of cameras

Camera variation that allows you to freely select from 16 types of area cameras + 3 types of line scan cameras according to the application.













A build-up type image processing system that offers expandability

- The full capabilities of the controller are demonstrated to the fullest extent by 3 expansion units and it is the first in the industry to support the mixed connection of line-scan cameras and area cameras
- A build-up type controller that offers expandability



Area camera

Type	Model	Specification	CCD capture range (pixels)	Image transfer time (ms)
5 million-pixel camera series	 11x 5 MEGA DIGITAL	XG-H500M XG-H500C	11x high-speed monochrome 11x high-speed colour	2432 × 2050 2432 × 2050 
		 7x MEGA DIGITAL	XG-H200M XG-H200C	7x high-speed monochrome 7x high-speed colour
XG-200M XG-200C	Monochrome Colour		1600 × 1200 1600 × 1200 	
XG-S200M XG-S200C	Ultra-compact monochrome Ultra-compact colour		1600 × 1200 1600 × 1200 	
MEGA DIGITAL SUPER-SMALL DIGITAL				
1 million-pixel camera series	 7x MEGA DIGITAL	XG-H100M XG-H100C	7x high-speed monochrome 7x high-speed colour	1000 × 1000 1000 × 1000 
310,000 pixel camera series	 7x HI-SPEED DIGITAL	XG-H035M XG-H035C	7x high-speed monochrome 7x high-speed colour	640 × 480 640 × 480 
		XG-035M XG-035C	Monochrome Colour	640 × 480 640 × 480 
		XG-S035M XG-S035C	Ultra-compact monochrome Ultra-compact colour	640 × 480 640 × 480 
		HI-SPEED DIGITAL ULTRA-SMALL DIGITAL		

Line scan camera



Model	XG-HL02M
Applicable lens	1 in. C-mount
Number of pixels	2048
Max. expanded image size	2048 × 16384
Scan speed	24 μS/line
Pixel clock	100 MHz (8x transfer)



Model	XG-HL04M
Applicable lens	1 in. C-mount
Number of pixels	4096
Max. expanded image size	4096 × 16384
Scan speed	24 μS/line
Pixel clock	200 MHz (16x transfer)



Model	XG-HL08M
Applicable lens	2 in. (M40 P0.75) lens*
Number of pixels	8192
Max. expanded image size	8192 × 8192
Scan speed	45 μS/line
Pixel clock	200 MHz (16x transfer)

*Supports F-mount conversion adapter

Digital Microscope



Super Resolution Imaging

World's First

This new method of high-resolution imaging involves illuminating an object with short-wavelength blue light and capturing the image with KEYENCE's original pixel shift method. This is made possible by designing the camera, zoom lens, and graphics engine to work together.

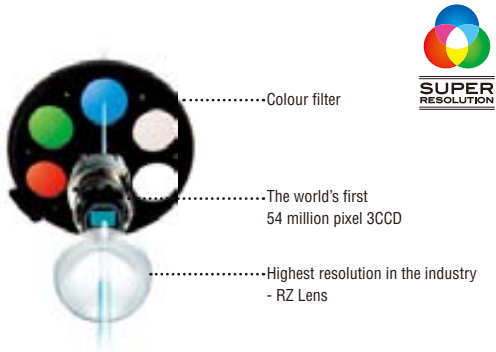

LARGE DEPTH-OF-FIELD

Easily capture fully-focused, high-resolution images

Conventional Microscope



Focus on only a part of a target

VHX Series



Sharp focus on the entire target



Hand-held observation

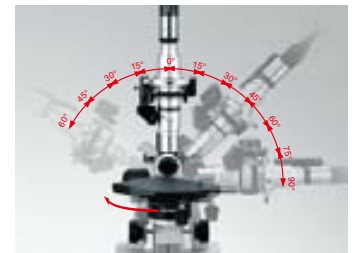

Free-angle observation system

Simple operation using 3-axis (XYZ) motorised control

Industry's First

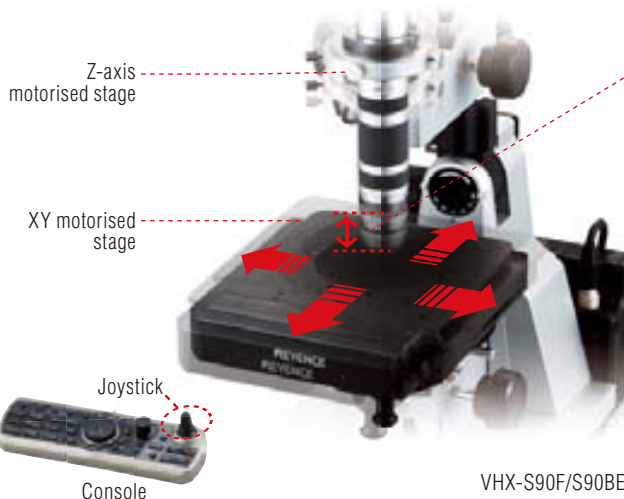

Auto Focus Function



A built-in auto-focus algorithm can be executed with the push of a button, eliminating complex focus adjustments and user subjectivity.

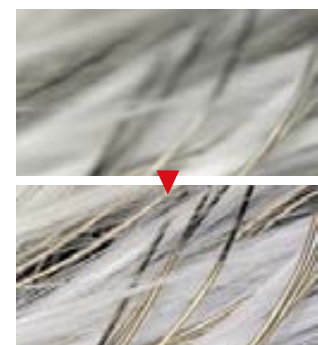

Fibre (50x)

High-speed Microscope



Records motion that previously could not be seen

Achieves 16 times the recording performance of conventional high-speed microscopes

We re-examined the camera element from scratch and developed a CMOS sensor that is best suited for magnified observation and recording high-speed video. Capable of providing 16 times the recording performance and more than 4 times the camera sensitivity compared to conventional models, the VW-9000 can record at up to 4,000 fps without dropping resolution (640 x 480).

Performance comparison Using VGA (640 x 480) recording

Previous high-speed microscopes could only record at a maximum of 250 fps at a resolution of 640 x 480. The VW-9000 Series can record video using the same resolution, but at 16 times the speed (4,000 fps).

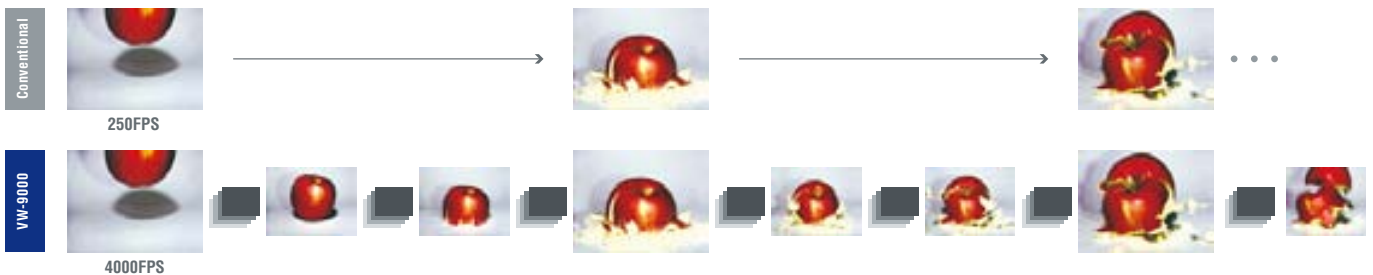

Set up and record in minutes

Minimise installation space and required equipment

TRADITIONALLY...

Conventional configurations require a considerable amount of equipment



THE VW-9000 SERIES OFFERS...

An LCD monitor, light source, and HDD built into an all-in-one design

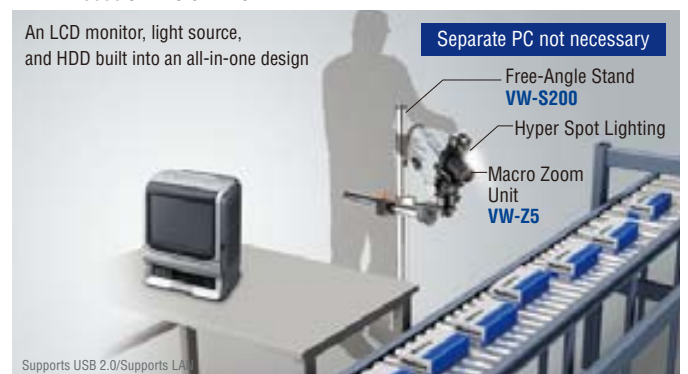

WORLDWIDE DIRECT SALES NETWORKS

(More than 200 offices in 44 countries)

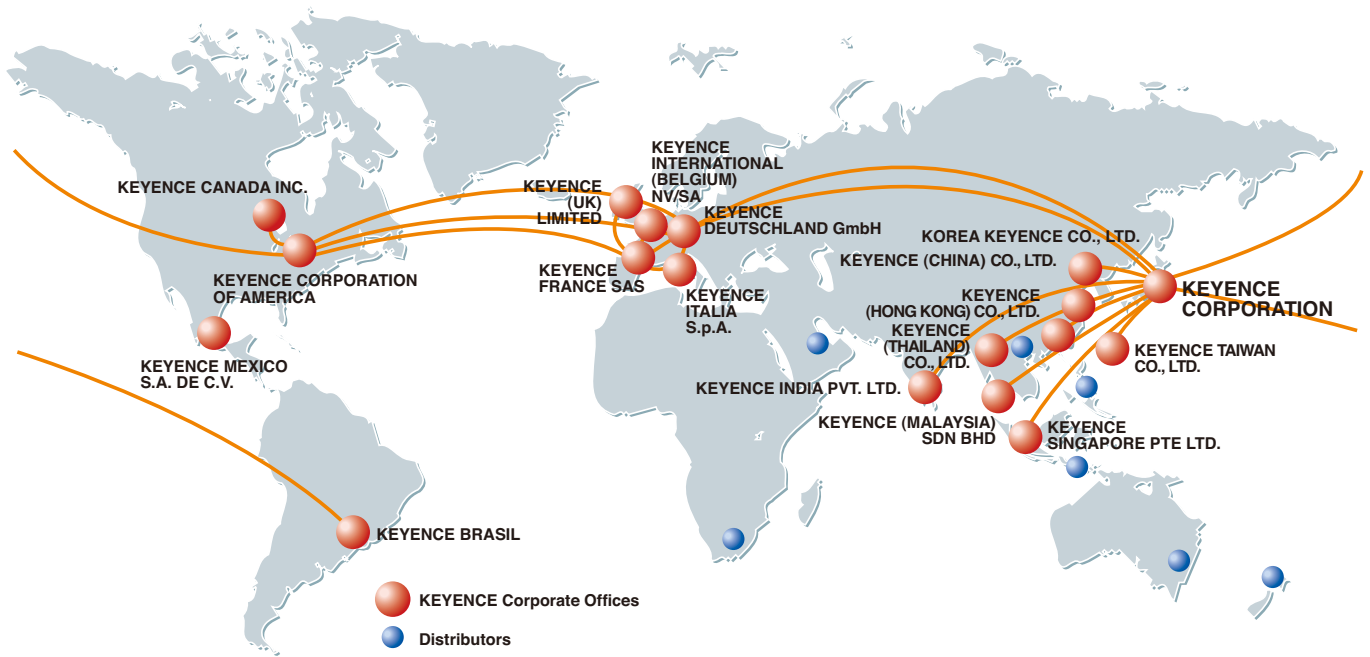

CONTACT US
+32 1-528-1222

www.keyence.eu
E-mail: info@keyence.eu



SAFETY INFORMATION

Please read the instruction manual carefully in order to safely operate any KEYENCE product.

KEYENCE INTERNATIONAL (BELGIUM) NV/SA

Head office Bedrijvenlaan 5, 2800 Mechelen, Belgium Tel: +32 1-528-1222 Fax: +32 1-520-1623

Regional sales offices

BELGIUM

Tel: +32 1-528-1220
Fax: +32 1-520-1623

AUSTRIA

Tel: +43 22-36-3782-66-0
Fax: +43 22-36-3782-66-30

CZECH REPUBLIC

Tel: +420 222-191-483
Fax: +420 222-191-505

HUNGARY

Tel: +36 1-802-73-60
Fax: +36 1-802-73-61

NETHERLANDS

Tel: +31 40-20-66-100
Fax: +31 40-20-66-111

POLAND

Tel: +48 71-36861-60
Fax: +48 71-36861-62

ROMANIA

Tel: +40 269-232-808
Fax: +40 269-232-808

SLOVAKIA

Tel: +421 2-5939-6461
Fax: +421 2-5939-6200

SLOVENIA

Tel: +386 1-4701-666
Fax: +386 1-4701-699

SWITZERLAND

Tel: +41 43-45577-30
Fax: +41 43-45577-40

KEYENCE CORPORATION

1-3-14, Higashi-Nakajima, Higashi-Yodogawa-ku, Osaka, 533-8555, Japan PHONE: +81-6-6379-2211

The information in this publication is based on KEYENCE's internal research/evaluation at the time of release and is subject to change without notice.
Copyright (c) 2013 KEYENCE CORPORATION. All rights reserved. KIBLineup-KIB-C3-GB 1023-2 [626095] Printed in Japan

KIB1-1013

