



Main catalog

Electricity meters For modular enclosures and DIN rail

Power and productivity
for a better world™



Introduction

DIN rail mounted electricity meters

Modular DIN rail products offer a wide range of functions to be integrated in electrical installations with significant benefits for the user. DIN rail mounted electricity meters are designed for high level performance and are safe and fast to install. The DIN rail mounted electricity meters are available in several models: the new EQ meters C11, B21, A41 and A42 for single phase metering, the new EQ meters C13, B23, B24, A43 and A44 for three phase metering.

ABB Low Voltage Products

The Low Voltage Products division manufactures low voltage circuit breakers, switches, control products, wiring accessories, enclosures and cable systems to protect people, installations and electronic equipment from electrical overload. The division further makes KNX systems that integrate and automate a building's electrical installations, ventilation systems, and security and data communication networks. All these products help customers to save energy, improve productivity and increase safety.

Global business

The Low Voltage Products division is a global business producing mainly low-voltage electrical equipment that is sold to

wholesalers, original equipment manufacturers as well as system integrators, and has moderate service requirements.

ABB's broad program of standardized products and components are the 'building blocks' of system solutions, incorporating functionalities that will allow seamless integration in real time automation and information systems. At the product level, all the low voltage products can operate together perfectly.

To create a system solution, every product is equipped with the tools necessary to install, operate and maintain it efficiently throughout the product life cycle.

The range of low voltage products is supported by technical documentation. This together with compact design makes it easier than ever to incorporate our products in your system.

Our customers can find all product related documentation such as brochures, catalogues, selection program, certificates, drawings and other information directly at

www.abb.com/lowvoltage



Table of contents

Introduction	1
A series	2
B series	3
C series and accessories	4
Communication products	5
Cross reference	6

Disclaimer

The information in this document is subject to change without notice and should not be construed as a commitment by ABB AB. ABB AB assumes no responsibility for any errors that may appear in this document.

In no event shall ABB AB be liable for direct, indirect, special, incidental or consequential damages of any nature or kind arising from the use of this document, nor shall ABB AB be liable for incidental or consequential damages arising from use of any software or hardware described in this document.

A smart investment – a green investment

1



The world's energy consumption is growing. Luckily, so is its eco-awareness. Investments in infrastructure and power distributions are made in order to meet with growing demands of electric energy. As a result, the energy and distribution costs are driven upwards. Now more than ever is it important for any type of business to be energy efficient.

Most major companies today strive towards leaving an ecological footprint as small as possible. It is in their fundamental values to be energy efficient. It helps the company's image while it at the same time saves money, resources and perhaps most importantly – the environment.

All over customers ask for environmental friendly products and solutions. Politicians state that energy efficiency should be a focus area in today's society and new buildings and industries are designed accordingly: energy efficient.

Information is key

For any utility manager, landlord or anyone managing a company's or building's energy resources, a utility meter and the information it provides usually is not sufficient. One bill and no information of where or why the energy is wasted.

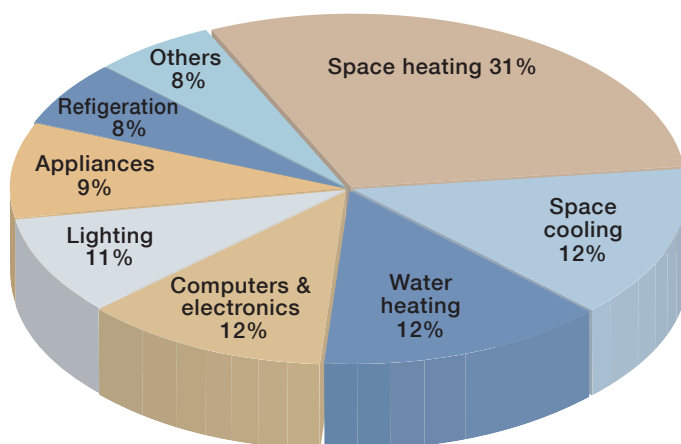

Sub-metering, on the other hand, provides a far more detailed picture of the energy consumption. It helps you identify specific areas where the energy consumption is too high and essentially where investments need to be made. With a sub-meter you can look into the details of your energy consumption and take actions where it's needed the most.

Strike the perfect balance



In the World Energy outlook for 2012 the International Energy Agency (IEA), states: "A significant share of the potential to improve energy efficiency – four fifths of the potential in the buildings sector and more than half in industry – still remains untapped." Is your company or organization doing enough to reduce its energy consumption? The high-quality, simple-to-install and easy-to-use EQ meters from ABB help save energy, costs and resources.

EQ meters from ABB provide detailed information about energy consumption. Get specific information on tenants energy consumption or see where in a factory energy is wasted. The EQ meters are high-performing, modular DIN rail mounted electricity meters that are safe and easy to use. Designed for simple integration with any existing or future electrical installation, the EQ meters from ABB can be installed and operating in minimal time. Not only do they provide detailed information about energy consumption, but also act as a tool for building an improved and efficient infrastructure that ultimately leads to a greener world.

Three key drivers

"You can't manage what you don't monitor" is an old saying and rule that applies to energy consumption. Managing energy is knowing exactly when, where and how it is being used. In order to implement "green" programs to reduce energy, this information is a requirement and is provided by the EQ meters from ABB. Property and facility managers will be able to meet local, national and international mandates, and allocate and distribute costs in an accurate and fair way.

React in advance

To improve energy management, knowledge of consumption patterns is important. Climate concerns, rising energy costs, and to some degree, energy efficiency legislations are driving the demands for sub-metering. It is important to acknowledge such trends in an early stage. With a plotted pattern of sub-meters, you can anticipate trends and plan for them in advance. Knowing is half the battle.



This QR-code is linked to the latest version of our movie. You will have to download a QR-code reader app to your phone in order to use it.

Applications in commercial buildings

1



Modern sub-metering increases energy efficiency and saves money by fair and accurate cost distribution.

Requirements for a deliberate strategy to manage and control energy consumption are having an increasing impact on commercial buildings such as shopping centers, offices, hotels and airports.

Electricity meters in commercial buildings are usually acquired by the property owner and read automatically via a facility or building management system. Just like for private property, modern sub-metering solutions can increase energy efficiency in commercial buildings and make considerable savings.

MID approval facilitates problem-free cost distribution

Meters that are MID approved have the advantage of a certified and verified metering accuracy. This is important if discussions on the fairness of the cost distribution arise.

EQ meters can easily help distribute consumption costs between different tenants, e.g. stores and boutiques in shopping malls, businesses in office blocks, or different airlines and functions (baggage handling, for example) at airports.

The fact that many commercial properties are not designed from the beginning for sub-metering presents no problem. EQ meters fit neatly wherever they are needed.

Mandatory energy declarations in EU require consumption to be separated

According to EU directive 2010/31/EU, commercial properties must have an energy declaration that describes the building's energy performance. Its aim is to reduce the climate effect and increase the efficient use of energy, i.e. benefits for both society and the building owner.

Energy declarations require that the electrical consumption for lighting, elevators, heating and ventilation, etc., be accounted for separately. Data collected from individually-located meters (sub-metering) are extremely valuable in this respect. As well as being a legal requirement, it highlights ways to increase efficiency by locating unnecessary energy consumption.

ISO 50001, LEED, BREEAM and others

Whichever you aim for, analyzing energy consumption is an important early step and in the end also the best way to maintain an achieved level. EQ meters will provide accurate information regarding the electrical energy consumption.

Max demand also cuts energy consumption

Measuring the highest average power during a set time interval results in the max demand value. Measuring max demand helps dimension a building's electrical installations to its use.

Industrial applications



EQ meters from ABB help industry manage electricity cost distribution and make more effective use of the energy it consumes.

EQ meters from ABB find many uses in industry, usually in one of three areas; cost distribution, effective use of energy and improved control. One common feature is that they generally interact with a plant's Energy Management System, which reads the meter and then forwards the result for further handling.

Meters used in industrial applications do not need special approval. Common sense, however, says that high quality meters like ABB's are essential. That they should meet accepted international standards is also obvious. And as industrial plant owners frequently mount electrical equipment on DIN rails, EQ meters from ABB with this capability has a clear advantage.

Fair and flexible cost distribution

Industry faces a never ending challenge to keep down its operating costs. One of the prerequisites for achieving this goal is to first identify where costs occur. Only then can factory management draw up guidelines on how these should be allocated and who should pay for them, i.e. according to department, profit center or even individual products.

Meters help maximize energy efficiency

Making the most effective use of costly energy remains a key priority. Measuring the electrical consumption of equipment,

especially heavy equipment, is a vital job for EQ meters from ABB in this respect. For example, an unexpected increase in the energy use of an individual item can signal an urgent need for maintenance – and a return to more acceptable and budgeted levels.

Peak-shaving saves unnecessary extra costs

Many industrial contracts for electricity supply specify a maximum power that can be taken from the grid. Exceeding this level can mean costly extra tariffs, especially in energy-intensive operations.

Max demand also cuts industrial energy consumption

Measuring the highest average power during a set time interval results in the max demand value. Using meters from ABB to measure max demand helps cut consumption by more easily identifying time periods when energy use is very high so that appropriate measures to reduce it can be taken.

Mitigating the effects of harmonic distortion

Harmonic distortion is the change in the waveform of the supply voltage from the ideal sinusoidal form. The phenomenon can adversely affect industrial equipment such as induction motor windings, transformers and capacitors. Reducing harmonic distortion first requires a harmonic analysis, and here meters from ABB have an important role to play.

Object metering

1

Electric bills keep rising, and increased consumption probably plays a bigger part than higher prices. At home and at work, energy hungry items like computers, terminals, servers, climate control equipment and intense lighting all push up costs. One of the simplest ways to save money and energy is to make electricity consumption more visible – via object metering.

Object metering is metering an individual commercial freezers, lighting, machines, power consuming objects such as air conditioning fans or heating pumps. Its aim is to show electricity use where it occurs, thereby increasing energy awareness and helping change consumer behavior.

Easy installation in standard enclosures together with MCB protection

The compact electricity meters from ABB are easy to install in standard enclosures. This is especially important in object metering since objects in domestic, commercial and industrial applications require line protection devices, and these are generally mounted in standard enclosures.

Long list of domestic objects

Heating and ventilation pumps are obvious candidates for object metering in the home, and these can be joined by appliances such as washing machines and dishwashers as

well as other electronic equipment. And don't forget outdoors. Garden terrace heaters and lighting plus the pond pump are all significant energy thieves. The actual consumption of all is easy to measure and see (and therefore save) via compact meters in the home.

Many opportunities in commercial properties

Commercial properties naturally feature a wealth of objects to measure, including many of the items found in everyday homes. But engineers are now exploring ways to get modern, large scale buildings to produce energy as well as consume it. Elevator cars, for example, generate energy when they descend or brake and this can be returned to the building's power grid as electricity for lighting or heating.

Industry shares similar needs

In addition to normal units for heating, lighting, ventilation and office administration, industrial premises contain usually processing machinery, conveyers, transport systems, and a great deal of electrical protection devices. Object consumption data measured by meters can be fed to Energy Management Systems for analysis to see how energy costs can be cut.

“To measure is to know”



Object metering is used to show the electricity consumption where it occurs

Landlord sub-metering

Unlike applications where a separate billing meter is installed in every apartment or residence for individual billing, landlord sub-metering involves having one central billing meter. The landlord, condominium, housing association or equivalent then acts as a single electricity subscriber and redistributes its costs amongst its tenants according to their actual consumption. The latter is measured by a simple DIN-meter in each apartment.

The attractions are many. Direct savings are won via reduced network charges, i.e. electricity is supplied to just one subscriber instead of a subscriber in every apartment. The subscriber then has a much better bargaining position when negotiating prices with energy companies, which should lead to lower prices for all.

Reliable and easy to implement

Landlord sub-metering is easy to implement. Usually no formal approval is required, but this may vary from country to country depending on local rules and legislation. Electricity meters from ABB help alleviate common concerns as they are approved for billing applications within the EU/EEC, i.e. they are MID-approved (see next page). Tenants can thus trust their use in the sub-metering.

Simple installation in standard enclosures

DIN rail type of meters is often used to distribute costs between apartments are simple to install. Small enough to fit in standard DIN enclosures, they require no special housing or rebuilding work. The data they generate are normally collected by pulse or serial readings transmitted continuously to a central unit (the latter also allows access to additional data). At the simplest level, the meters can be read manually.

Sub-metering brings on energy awareness

Experience shows that occupiers save up to 30% on electricity bills when they can see their own consumption. This is not surprising. When individual occupiers get a clear picture that relates electricity use to activity, they know exactly where savings can be made.

Cost savings also benefit the environment

Knowing how and where electricity costs arise will also help improve the environment by cutting the need for unnecessary electrical energy production. A specific example is the multitude of devices with stand-by consumption, i.e. connected to the mains supply but not in use. These include transformers for mobile phone chargers, TVs and computers, halogen lamps, etc.



Landlord sub-metering offers clear cost-saving opportunities for the tenants, at the same time as it benefits the environment.

Selection guide

1

How do I select the best meter for my application?

There are many versions of EQ meters in order to meet your requests. The EQ program comprises meters with different functionalities such as tariffs, communication interfaces or advanced clock functions. Spend a little time to evaluate the functions and imagine how they could add extra value to your metering. For example, the input counter (from silver level) on an EQ meter can be used to count products produced by a machine and be read out together with the energy consumption of the same machine. In one easy go you can allocate energy to any produced product from one source. Another useful function is previous values (from gold level). If you charge users in intervals the meter can secure the data even in the event of a broken communication link. You can collect the correct interval data later and also make it visible for your counterpart immediately on the meters display in case of any discussions.

Make the meter an asset.

Take the step from passive meter reading to an active user of the data you can retrieve. The meter can be an important asset for you in order to avoid costs like penalties or extra charge for reactive energy (from bronze level). Keep track of your maximum demand and reduce them to avoid charges. EQ meters can tell you the value of the maximum demand and also when it occurred. Harmonics is the source of many problems for all sorts of equipment connected to the low voltage network. Use an EQ meter (platinum level) to measure the THD and isolate the source before you have to take the cost and consequences of poor power quality

Function	Single phase				Three phase				
	C11	B21	A41	A42	C13	B23	B24	A43	A44
Direct connected	1	1 2 3	1 2 3 4 5		1	1 2 3		1 2 3 4 5	
Transformer connected				1 2 3 4 5			1 2 3		1 2 3 4 5
2 element metering						1 2 3	1 2 3	1 2 3 4 5	1 2 3 4 5
3 element metering					1	1 2 3	1 2 3	1 2 3 4 5	1 2 3 4 5
Accuracy 1%, Class 1, Class B	1	1 2 3	1 2 3 4 5	1 2 3 4	1	1 2 3	1 2	1 2 3 4 5	1 2 3
Accuracy 0,5%, Class 0,5 S, Class C				5			3		3 4 5
Active energy	1	1 2 3	1 2 3 4 5	1 2 3 4 5	1	1 2 3	1 2 3	1 2 3 4 5	1 2 3 4 5
Reactive energy		2 3	2 3 4 5	2 3 4 5		2 3	2 3	2 3 4 5	2 3 4 5
Apparent energy		2 3	2 3 4 5	2 3 4 5		2 3	2 3	2 3 4 5	2 3 4 5
Import/Export energy		2 3	2 3 4 5	2 3 4 5		2 3	2 3	2 3 4 5	2 3 4 5
Tariff registers, 1-4		3	3 4 5	3 4 5		3	3	3 4 5	3 4 5
Instrument values	1	1 2 3	1 2 3 4 5	1 2 3 4 5	1	1 2 3	1 2 3	1 2 3 4 5	1 2 3 4 5
Alarm function	1	1 2 3	1 2 3 4 5	1 2 3 4 5	1	1 2 3	1 2 3	1 2 3 4 5	1 2 3 4 5
Harmonics, THD and no 2-16				5				5	5
Previous values - day, week, month			4 5	4 5				4 5	4 5
Max and min demand			4 5	4 5				4 5	4 5
Load profiles - 8 channels				5				5	5
Pulse output	1	1 2	1 2	1 2	1	1 2	1 2	1 2	1 2
I/O board - 2 in, 2 out		3	3 4	3 4		3	3	3 4	3 4
Configurable I/O - 4 I/O channels				5				5	5
Tariffs controlled by input		3	3 4 5	3 4 5		3	3	3 4 5	3 4 5
Tariffs controlled by communication		3	3 4 5	3 4 5		3	3	3 4 5	3 4 5
Tariffs controlled by clock			4 5	4 5				4 5	4 5
MID approved, verified	optional	1 2 3	1 2 3 4 5	1 2 3 4 5	optional	1 2 3	1 2 3	1 2 3 4 5	1 2 3 4 5
IEC approved	1	1 2 3	1 2 3 4 5	1 2 3 4 5	1	1 2 3	1 2 3	1 2 3 4 5	1 2 3 4 5
Communication - Infrared (M-Bus)		1 2 3	1 2 3 4 5	1 2 3 4 5		1 2 3	1 2 3	1 2 3 4 5	1 2 3 4 5
Communication - M-Bus		optional	optional	optional		optional	optional	optional	optional
Communication - RS-485 Modbus		optional	optional	optional		optional	optional	optional	optional
Communication - RS-485 EQ bus		optional	optional	optional		optional	optional	optional	optional

- 1 = Steel
- 2 = Bronze
- 3 = Silver
- 4 = Gold
- 5 = Platinum
- = Not available
- Optional = Available on some order codes

Connection of EQ meters

There are both one phase and three phase meters in the program. When the current exceeds the maximum current for a direct connected meter, a meter can be used from A or B series with current transformers (CT's). If the voltage is outside the specification of the meter you can use an A series meter with voltage transformers (VT's). Please note that three phase meters in A and B series can be configured to be used in three or four wire applications.

C, B and A series

	Single phase				Three phase				
	C11	B21	A41	A42	C13	B23	B24	A43	A44
Connection	Direct	Direct	Direct	CTVT	Direct	Direct	CT	Direct	CTVT
Max Amp	40A	65A	80A	6A ^{*)}	40A	65A	6A ^{*)}	80A	6A ^{*)}
Communication	-	IR, M-Bus, RS-485	IR, M-Bus, RS-485	IR, M-Bus, RS-485	-	IR, M-Bus, RS-485	IR, M-Bus, RS-485	IR, M-Bus, RS-485	IR, M-Bus, RS-485
Functionality	1	1 2 3	1 2 3 4 5	1 2 3 4 5	1	1 2 3	1 2 3	1 2 3 4 5	1 2 3 4 5

- 1 = Steel
 - 2 = Bronze
 - 3 = Silver
 - 4 = Gold
 - 5 = Platinum
 - = Not available
- Optional = Available on some order codes

^{*)} 6A is the secondary current of a connected current transformer used in cases with currents exceeding the max current for direct connected meters.



A series

Product brief

2



Key applications

- Applications in industry
- Applications in commercial buildings
- Object metering
- Billing applications

Meter performance

- Three phase and single phase
- Direct connected up to 80 A
- Transformer connected 1, 2 or 5 A
- Active or active and reactive energy
- Accuracy class C, B or A (Cl. 0,5 S, 1 or 2)
- Import or import and export measurement of energy
- Wide voltage range (100 – 500 V)
- Pixel-oriented display
- Up to 4 tariffs
- Up to 4 inputs and outputs
- Low power consumption
- Optional clock functionality with tariff control, previous values, max/min demand, load profiles
- Harmonics measurement up to 16th harmonic and THD evaluation

Communication

- Pulse output
- Built-in M-Bus
- Built-in RS-485 for Modbus RTU and EQ bus
- IR port for Serial Communication Adapters

Installation

- Terminal according to DIN 43857 ("Utility terminal")
- Wide temperature range
- Sealable push buttons for configuration

Approvals

- MID type approval "annex B"
- MID initial verification "annex D"
- IEC type approval

A series Description

The A series EQ meters are meters for single phase and three phase metering. The A series meters are mounted on a DIN rail and are suitable for installation in distribution boards and small enclosures such as consumer units. With the main terminals in accordance with DIN 43857 and accessible from the below the meters, the A series is suitable for many applications.

General features

The A series meters are ideal for many applications and installations. The meters support a wide voltage range as well as a wide temperature range. The display is pixel-oriented and can display up to four quantities at the same time. Navigating the meter is easily done via the push-buttons below the display. To configure the meter settings, the set button must be accessed and this button is protected against unauthorized use when the “glass lid” on the front of the meter is closed and sealed. The power consumption of the meter is very low, less than 0.8 VA.

Communication

Data from the A series meters can be collected via pulse output or serial communication. The pulse output is a solid state relay that generates pulses proportionally to the measured energy. The meters can also be equipped with built-in serial communication interfaces for M-Bus or Modbus RTU (RS-485). Meters with RS-485 interface can also be set to communicate over the new EQ bus with the new gateway G13. All meters in the A series come with an infrared port for communication with an external Serial Communication Adapter (SCA) such as the KNX adapter.

Instrumentation

The A series meters support reading of instrument values. A large number of electrical properties can be read. Depending on version of the meter the following data is available:

- Active power
- Apparent power
- Reactive power
- Current
- Voltage
- Frequency
- Power factor
- Harmonics
- Total harmonic distortion

Inputs and outputs

The A series support up to four I/O's. It can be two inputs and two outputs in a fixed configuration or four I/O points that are freely configured to input or output. Inputs can be used for counting pulses from e.g. a water meter, or reading status



from external devices. Outputs can be used as pulse outputs or controlling external apparatus like a contactor or an alarm (connected via an external relay). Outputs need an external voltage supply.

Approvals

The A series meters are type approved according to IEC and they are both type approved and verified according to MID. MID is the Measuring Instruments Directive 2004/22/EC from the European Commission. MID type approval and verification is mandatory for meters in billing applications within EU and EEA. The type approval is according to standards that covers all relevant technical aspects of the meter. These include climate conditions, electromagnetic compatibility (EMC), electrical requirements, mechanical requirements and accuracy.

Tariffs

The tariffs are controlled via inputs, via communication or via an internal clock.

Event log

Gold and Platinum meters have an event log function. The event log will log overvoltage, undervoltage, phase voltage outage, negative power, total power outage and presence of harmonics.

Optional functionality

A series meters with a functionality level of Gold or Platinum have an internal clock for advanced functionality. The clock functions are briefly presented below.

A series Description

2

Internal clock

The internal clock, sometimes called real time clock or RTC, has a built-in calendar and automatically keeps track of leap year and daylight savings time (DST). The DST function is optional. Backup of the clock during a power failure is provided by a supercapacitor. The time is controlled by a quartz crystal based clock. Time and date is set via push buttons or via communication. The internal clock is approved according to IEC 62052-21 and IEC 62054-21. These standards specify the requirements for time switches in electricity meter related products. The accuracy is better than 5 ppm at room temperature.

Previous values

The previous value feature is available on Gold and Platinum meters and will store all energy registers and input counter values together with a date/time stamp upon change of day, week or month. All total values are stored and in meters equipped with the tariff feature all the tariff registers will also be stored.

Maximum and minimum demand

The demand function is available on Gold and Platinum meters. In the demand function, the mean power in each interval is measured and the maximum and minimum mean values are stored together with a date/time stamp.

For each set of demand values the end date/time of the period is stored. The quantities that can be stored for each interval are active, reactive and apparent power (imported power only), and the number of pulses registered on inputs.

Load profile

The load profile function is available on the Platinum meters. The load profile stores the energy consumption at pre-defined intervals. The quantities that can be stored for each interval are active and reactive energy, both imported and exported energy, and the number of pulses registered on inputs. The load profile function uses the standard time setting irrespective if the daylight savings time function is activated or not.

THD

The THD and harmonics measurement is available on the Platinum meters. The voltage and current harmonics (2-16) together with the fundamental is measured sequentially one at a time. The total harmonic distortion is evaluated and displayed in percent. The separate harmonic frequencies measured are multiples of the fundamental frequency up to the 16th harmonic. THD data as well as individual harmonics are shown on the display. THD data and data for individual harmonics can also be read out via serial communication.



A41

Single phase meter

80A, 4 DIN with IR port



A41

Description

Direct connected electricity meter. Verified and approved according to MID. IEC approval. Instrument values. Alarm function. Communication - Infrared (M-Bus). Optional - Communication with M-Bus, RS-485 Modbus, RS-485 EQ bus.

Ordering details

Voltage V	Accuracy Class	I/O	Communication	Type	Order Code	Pkg qty	Weight 1 pc
Steel							
Active energy							
57.7...288 V AC	Class B (Cl. 1)	Pulse output	-	A41 111 - 100	2CMA170554R1000	1	0.23
			RS-485	A41 112 - 100	2CMA170500R1000	1	0.23
			M-Bus	A41 113 - 100	2CMA100240R1000	1	0.23
Bronze							
Active and reactive energy, import/export.							
57.7...288 V AC	Class B (Cl. 1) Reactive Cl. 2	Pulse output	RS-485	A41 212 - 100	2CMA170501R1000	1	0.23
Silver							
Active and reactive energy, import/export, tariffs 1-4, tariff control via inputs and communication.							
57.7...288 V AC	Class B (Cl. 1) Reactive Cl. 2	2 output, 2 input	-	A41 311 - 100	2CMA170502R1000	1	0.23
			RS-485	A41 312 - 100	2CMA170503R1000	1	0.23
			M-Bus	A41 313 - 100	2CMA170504R1000	1	0.23
Gold							
Active and reactive energy, import/export, tariffs 1-4, tariff controlled via inputs, communication or clock, previous values, max and min demand.							
57.7...288 V AC	Class B (Cl. 1) Reactive Cl. 2	2 output, 2 input	RS-485	A41 412 - 100	2CMA170505R1000	1	0.23
			M-Bus	A41 413 - 100	2CMA170506R1000	1	0.23
Platinum							
Active and reactive energy, import/export, tariffs 1-4, tariff controlled via inputs, communication or clock, previous values, max and min demand, advanced load profiles, harmonics and THD.							
57.7...288 V AC	Class B (Cl. 1) Reactive Cl. 2	Configurable 4 I/O channels	RS-485	A41 512 - 100	2CMA100237R1000	1	0.23
			M-Bus	A41 513 - 100	2CMA170508R1000	1	0.23

Dimensions

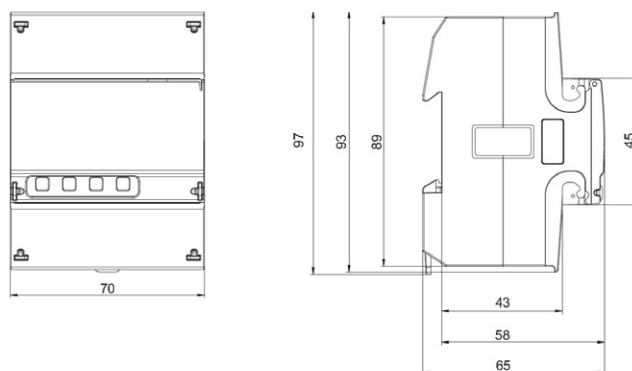

A42

Single phase meter

6A, 4 DIN with IR port

2



A42

2CMC481003C0201

Description

Transformer CT/VT connected electricity meter. Verified and approved according to MID. IEC approval. Voltage V - 57...288 V AC. Instrument values. Alarm function. Communication - Infrared (M-Bus). Optional - Communication with M-Bus, RS-485 Modbus, RS-485 EQ bus.

Ordering details

Voltage V	Accuracy Class	I/O	Communication	Type	Order Code	Pkg qty	Weight 1 pc
Steel							
Active energy							
57.7...288 V AC	Class B (Cl. 1)	Pulse output	-	A42 111 - 100	2CMA170555R1000	1	0.20
			RS-485	A42 112 - 100	2CMA170510R1000	1	0.20
			M-Bus	A42 113 - 100	2CMA100242R1000	1	0.20
Bronze							
Active and reactive energy, import/export.							
57.7...288 V AC	Class B (Cl. 1) Reactive Cl. 2	Pulse output	RS-485	A42 212 - 100	2CMA170511R1000	1	0.20
Silver							
Active and reactive energy, import/export, tariffs 1-4, tariff control via inputs and communication.							
57.7...288 V AC	Class B (Cl. 1) Reactive Cl. 2	2 output, 2 input	RS-485	A42 312 - 100	2CMA170512R1000	1	0.20
Gold							
Active and reactive energy, import/export, tariffs 1-4, tariff controlled via inputs, communication or clock, previous values, max and min demand.							
57.7...288 V AC	Class B (Cl. 1) Reactive Cl. 2	2 output, 2 input	RS-485	A42 412 - 100	2CMA170513R1000	1	0.20
			M-Bus	A42 413 - 100	2CMA170514R1000	1	0.20
Platinum							
Active and reactive energy, import/export, tariffs 1-4, tariff controlled via inputs, communication or clock, previous values, max and min demand, advanced load profiles, harmonics and THD.							
57.7...288 V AC	Class C (Cl. 0,5 S) Reactive Cl. 2	Configurable 4 I/O channels	RS-485	A42 552 - 100	2CMA100238R1000	1	0.20
			M-Bus	A42 553 - 100	2CMA170516R1000	1	0.20

Dimensions

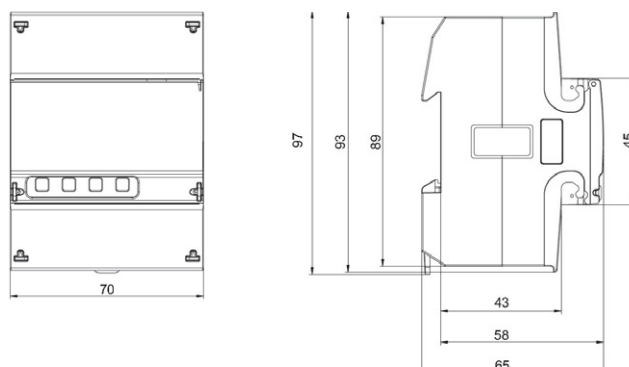

A43

Three phase meter

80A, 7 DIN with IR port



A43

2CMC481003C0201

Description

Direct connected electricity meter. Verified and approved according to MID. IEC approval. 2- and 3-element metering. Instrument values. Alarm function. Communication - Infrared (M-Bus). Optional - Communication with M-Bus, RS-485 Modbus, RS-485 EQ bus.

Ordering details

Voltage V	Accuracy Class	I/O	Communication	Type	Order Code	Pkg qty	Weight 1 pc
Steel							
Active energy							
3 x 57.7/100... 288/500 V AC	Class B (Cl. 1)	Pulse output	-	A43 111 - 100	2CMA170520R1000	1	0.44
			RS-485	A43 112 - 100	2CMA100244R1000	1	0.44
			M-Bus	A43 113 - 100	2CMA100245R1000	1	0.44
	Class A (Cl. 2)	-	A43 121 - 100	2CMA170521R1000	1	0.44	
Bronze							
Active and reactive energy, import/export.							
3 x 57.7/100... 288/500 V AC	Class B (Cl. 1) Reactive Cl. 2	Pulse output	-	A43 211 - 100	2CMA100012R1000	1	0.44
			RS-485	A43 212 - 100	2CMA170522R1000	1	0.44
			M-Bus	A43 213 - 100	2CMA170523R1000	1	0.44
Silver							
Active and reactive energy, import/export, tariffs 1-4, tariff control via inputs and communication.							
3 x 57.7/100... 288/500 V AC	Class B (Cl. 1) Reactive Cl. 2	2 output, 2 input	-	A43 311 - 100	2CMA170524R1000	1	0.44
			RS-485	A43 312 - 100	2CMA170525R1000	1	0.44
			M-Bus	A43 313 - 100	2CMA170526R1000	1	0.44
Gold							
Active and reactive energy, import/export, tariffs 1-4, tariff controlled via inputs, communication or clock, previous values, max and min demand.							
3 x 57.7/100... 288/500 V AC	Class B (Cl. 1) Reactive Cl. 2	2 output, 2 input	RS-485	A43 412 - 100	2CMA170528R1000	1	0.44
			M-Bus	A43 413 - 100	2CMA170529R1000	1	0.44
Platinum							
Active and reactive energy, import/export, tariffs 1-4, tariff controlled via inputs, communication or clock, previous values, max and min demand, advanced load profiles, harmonics and THD.							
3 x 57.7/100... 288/500 V AC	Class B (Cl. 1) Reactive Cl. 2	Configurable 4 I/O channels	-	A43 511 - 100	2CMA100143R1000	1	0.44
			RS-485	A43 512 - 100	2CMA170531R1000	1	0.44
			M-Bus	A43 513 - 100	2CMA170532R1000	1	0.44

Dimensions

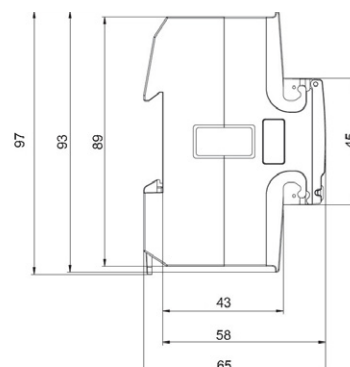
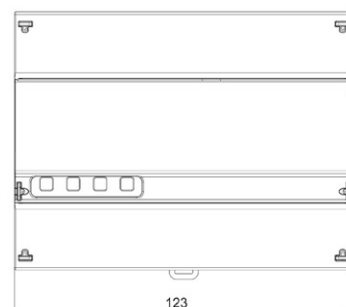

A44

Three phase meter

6A, 7 DIN with IR port

2



A44

Description

Transformer CTVT connected electricity meter. Verified and approved according to MID. IEC approval. 2- and 3-element metering. Instrument values. Alarm function. Communication - Infrared (M-Bus). Optional - Communication with M-Bus, RS-485 Modbus, RS-485 EQ bus.

Ordering details

Voltage V	Accuracy Class	I/O	Communi- cation	Type	Order Code	Pkg qty	Weight 1 pc
Steel							
Active energy							
3 x 57.7/100... 288/500 V AC	Class B (Cl. 1)	Pulse output	-	A44 111 - 100	2CMA170533R1000	1	0.35
			RS-485	A44 112 - 100	2CMA100248R1000	1	0.35
			M-Bus	A44 113 - 100	2CMA100249R1000	1	0.35
Bronze							
Active and reactive energy, import/export.							
3 x 57.7/100... 288/500 V AC	Class B (Cl. 1) Reactive Cl. 2	Pulse output	-	A44 211 - 100	2CMA100013R1000	1	0.35
			RS-485	A44 212 - 100	2CMA170534R1000	1	0.35
			M-Bus	A44 213 - 100	2CMA170535R1000	1	0.35
Silver							
Active and reactive energy, import/export, tariffs 1-4, tariff control via inputs and communication.							
3 x 57.7/100... 288/500 V AC	Class B (Cl. 1) Reactive Cl. 2	2 output, 2 input	-	A44 311 - 100	2CMA170536R1000	1	0.35
			RS-485	A44 352 - 100	2CMA170537R1000	1	0.35
			M-Bus	A44 353 - 100	2CMA170538R1000	1	0.35
Gold							
Active and reactive energy, import/export, tariffs 1-4, tariff controlled via inputs, communication or clock, previous values, max and min demand.							
3 x 57.7/100... 288/500 V AC	Class C (Cl. 0,5 S) Reactive Cl. 2	2 output, 2 input	RS-485	A44 452 - 100	2CMA170540R1000	1	0.35
			M-Bus	A44 453 - 100	2CMA170541R1000	1	0.35
Platinum							
Active and reactive energy, import/export, tariffs 1-4, tariff controlled via inputs, communication or clock, previous values, max and min demand, advanced load profiles, harmonics and THD.							
3 x 57.7/100... 288/500 V AC	Class C (Cl. 0,5 S) Reactive Cl. 2	Configurable 4 I/O channels	RS-485	A44 552 - 100	2CMA170545R1000	1	0.35
			M-Bus	A44 553 - 100	2CMA170546R1000	1	0.35

Dimensions

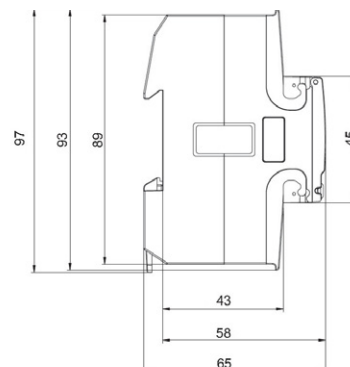
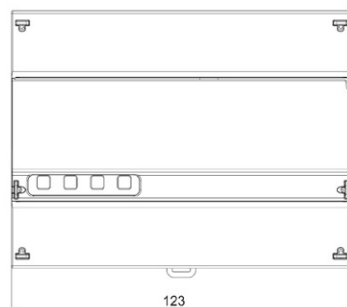

A series

Technical data

	A41	A42	A43	A44
Voltage/current inputs				
Nominal voltage	230 V AC		3x230/400 V AC	
Voltage range	57.7 - 288 V AC (-20% - +15%)		3x57.7/100 ... 288/500 V AC (-20% - +15%)	
Power dissipation voltage circuits	0.8 VA (0.8 W) total			
Power dissipation current circuits	0.007 VA (0.007 W) at 230 VAC	0.001 VA (0.001 W) at 230 VAC	0.007 VA (0.007 W) per phase at 230 VAC and I ₀	0.001 VA (0.001 W) per phase at 230 VAC and I ₀
Base current I _b	5 A	-	5 A	-
Rated current I _n	-	1 A	-	1 A
Reference current I _{ref}	5 A	-	5 A	-
Transitional current I _{tr}	0.5 A	0.05 A	0.5 A	0.05 A
Maximum current I _{max}	80 A	6 A	80 A	6 A
Minimum current I _{min}	0.25 A	0.02 A	0.25 A	0.01 A
Starting current I _{st}	< 20 mA	< 1 mA	< 20 mA	< 1 mA
Terminal wire area	1 - 25 mm ²	0.5 - 10 mm ²	1 - 25 mm ²	0.5 - 10 mm ²
Recommended tightening torque	3 Nm	1.5 Nm	3 Nm	1.5 Nm
Communication				
Terminal wire area	0.5 - 1 mm ²		0.5 - 1 mm ²	
Recommended tightening torque	0.25 Nm			
Transformer ratios				
Configurable voltage ratio (VT)	-	1/999 - 999999/1	-	1/999 - 999999/1
Configurable current ratio (CT)	-	1/9 - 9999/1	-	1/9 - 9999/1
Pulse indicator (LED)				
Pulse frequency	1000 imp/kWh	5000 imp/kWh	1000 imp/kWh	5000 imp/kWh
Pulse length	40 ms	40 ms	40 ms	40 ms
General data				
Frequency	50 or 60 Hz ± 5%			
Accuracy Class	B (Cl. 1) or Reactive Cl. 2	B (Cl. 1), C (Cl. 0.5 S) or Reactive Cl. 2	A (Cl. 2), B (Cl. 1) or Reactive Cl. 2	B (Cl. 1), C (Cl. 0.5 S) or Reactive Cl. 2
Active energy	1%	0.5%, 1%	1%, 2%	0.5%, 1%
Display of energy	Pixel oriented			
Environmental				
Operating temperature	-40°C - +70°C			
Storage temperature	-40°C - +85°C			
Humidity	75% yearly average, 95% on 30 days/year			
Resistance to fire and heat	Terminal 960°C, cover 650°C (IEC 60695-2-1)			
Resistance to water and dust	IP20 on terminal block without protective enclosure and IP51 in protective enclosure, according to IEC 60529.			
Mechanical environment	Class M1 in accordance with the Measuring Instrument Directive (MID), (2004/22/EC).			
Electromagnetic environment	Class E2 in accordance with the Measuring Instrument Directive (MID), (2004/22/EC).			
Outputs				
Current	2 - 100 mA			
Voltage	5 - 240 V AC/DC. For meters with only 1 output, 5 - 40 V DC.			
Pulse output frequency	Programmable: 1 - 999999 imp/kWh			
Pulse length	Programmable: 10 - 990 ms			
Terminal wire area	0.5 - 1 mm ²			
Recommended tightening torque	0.25 Nm			
Inputs				
Voltage	0 - 240 V AC/DC			
OFF	0 - 12 V AC/DC			
ON	57-240 V AC/24 - 240 V DC			
Min. pulse length	30 ms			
Terminal wire area	0.5 - 1 mm ²			
Recommended tightening torque	0.25 Nm			
EMC compatibility				
Impulse voltage test	6 kV 1.2/50 μs (IEC 60060-1)			
Surge voltage test	4 kV 1.2/50 μs (IEC 61000-4-5)			
Fast transient burn test	4 kV (IEC 61000-4-4)			
Immunity to electromagnetic HF-fields	80 MHz - 2 GHz at 10 V/m (IEC 61000-4-3)			
Immunity to conducted disturbance	150 kHz - 80 MHz, (IEC 61000-4-6)			
Immunity to disturbance with harmonics	2kHz - 150kHz			
Radio frequency emission	EN 55022, class B (CISPR22)			
Electrostatic discharge	15 kV (IEC 61000-4-2)			
Standards	IEC 62052-11, IEC 62053-21 class 1 & 2, IEC 62053-22 class 0,5 S, IEC 62053-23 class 2, IEC 62054-21, GB/T 17215.211-2006, GB/T 17215.321-2008 class 1 & 2, GB/T 17215.322-2008 class 0,5 S, GB 4208-2008, EN 50470-1, EN 50470-3 category A, B & C			
Mechanical				
Material	Polycarbonate in transparent front glass, bottom case, upper case and terminal cover, Glass reinforced polycarbonate in terminal block.			
Dimensions				
Width	70 mm		123 mm	
Height	97 mm		97 mm	
Depth	65 mm		65 mm	
DIN modules	4		7	

¹ Only A44 552 - 110 and A44 553 - 110

A series Wiring diagram

2

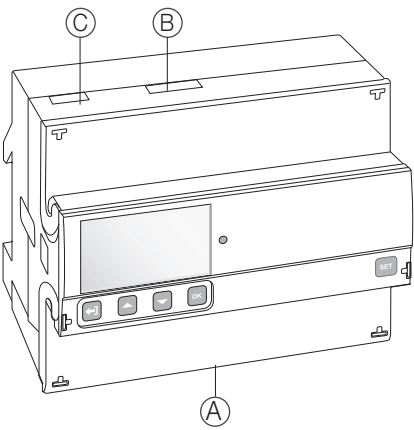
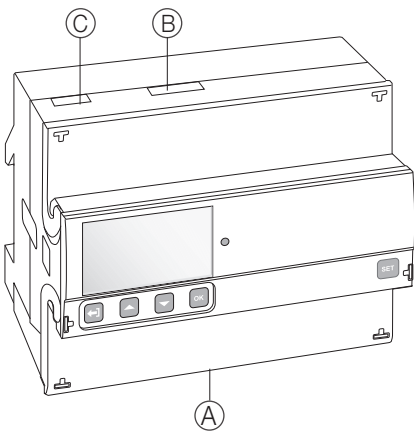
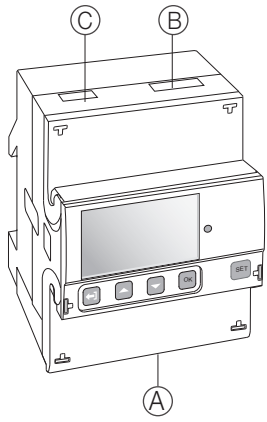

Terminal blocks A = Please see the pictures

A41

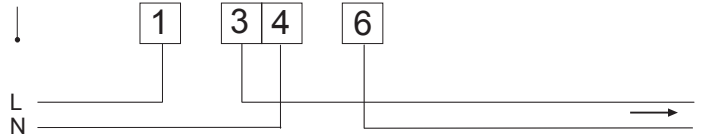

A42

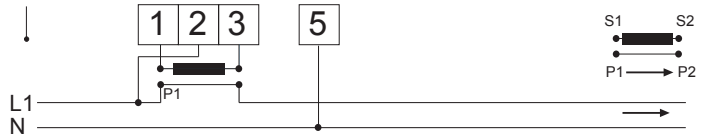

A43

3 wire connection, 2 elements

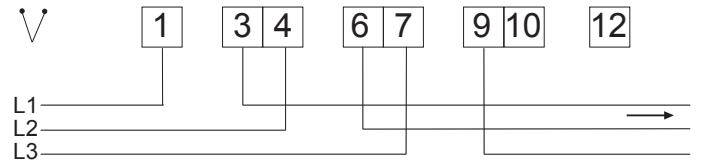

4 wire connection, 3 elements

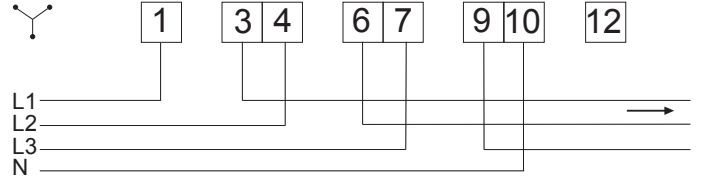

A44

3 wire connection, 2 elements

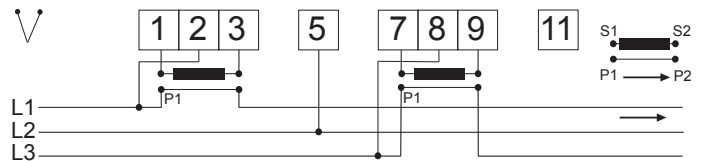

4 wire connection, 3 elements

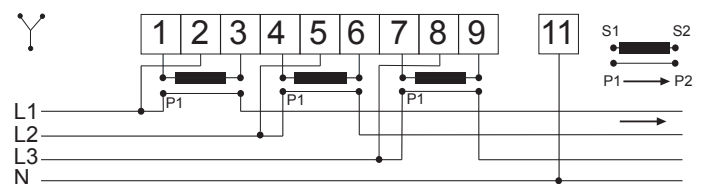

A series

Inputs/outputs and communication

Inputs/Outputs (B) = Please see the pictures on page 20

2 outputs, 2 inputs

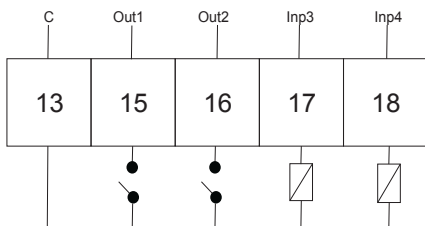

4 Configurable inputs/outputs

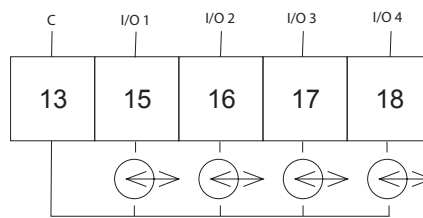

1 output

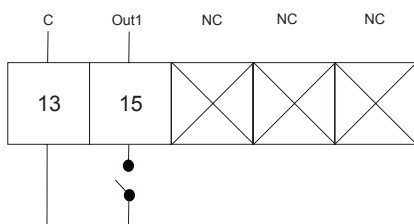

Communication (C) = Please see the pictures on page 20

RS-485

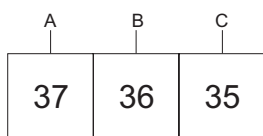

M-Bus

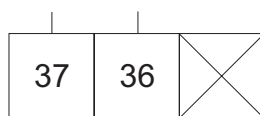

B series

Product brief

3



Key applications

- Applications in commercial buildings
- Object metering

Meter performance

- Single phase and three phase
- Direct connected up to 65 A
- Active or active and reactive energy
- Import or import and export of energy
- Accuracy class B (Cl. 1) or C (Cl. 0,5 S)
- Low power consumption
- Transformer connected 1, 2 or 5 A
- Up to 4 tariffs
- Alarm function

Communication

- Pulse output
- IR port for serial communication adapter
- Built-in M-Bus
- Built-in RS-485 for Modbus RTU or EQ bus

Installation

- Wide temperature range
- Easy configuration

Approvals

- MID type approval "annex B"
- MID initial verification "annex D"
- IEC type approval

B series

Description

The B series EQ meters are meters for single phase and three phase metering. The B series meters are mounted on a DIN rail and are suitable for installation in distribution boards and small enclosures such as consumer units. The B series are suitable in applications where there is a need for reliable energy measurements and where space is limited.

General features

The B series meters are high runner meters for many applications and installations. Navigating the meter is easily done via the push-buttons below the display. To configure the meter settings, the set button must be accessed and this button is protected against unauthorized use when the “glass lid” on the front of the meter is closed and sealed. The power consumption of the meter is very low, less than 0.8 VA.

Communication

Data from the B series meters can be collected via pulse output or serial communication. The pulse output is a solid state relay that generates pulses proportionally to the measured energy. The meters can also be equipped with built-in serial communication interfaces for M-Bus or Modbus RTU (RS-485). Meters with RS-485 interface can also be set to communicate over the new EQ bus with the new gateway G13. All meters in the B series come with an infrared port for communication with an external Serial Communication Adapter (SCA) such as the KNX adapter.

Instrumentation

The B series meters support reading of instrument values. A large number of electrical properties can be read. Depending on version of the meter the following data is available:

- Active power
- Apparent power
- Reactive power
- Current
- Voltage
- Frequency
- Power factor



Inputs and outputs

The B series support two inputs and two outputs in a fixed configuration. Inputs can be used for counting pulses from e.g. a water meter, or reading status from external devices. Outputs can be used as pulse outputs or controlling external apparatus like a contactor or an alarm (connected via an external relay).

Approvals

The B series meters are type approved according to IEC and they are both type approved and verified according to MID. MID is the Measuring Instruments Directive 2004/22/EC from the European Commission. MID type approval and verification is mandatory for meters in billing applications within EU and EEA. The type approval is according to standards that covers all relevant technical aspects of the meter. These include climate conditions, electromagnetic compatibility (EMC), electrical requirements, mechanical requirements and accuracy.

Tariffs

The tariffs are controlled via inputs or communication.

B21

Single phase meter

65A, 2 DIN with IR port

3



B21

Description

Direct connected electricity meter. Verified and approved according to MID. IEC approval. Instrument values. Alarm function. - Communication - Infrared (M-Bus).
Optional - Communication with M-Bus, RS-485 Modbus, RS-485 EQ bus.

Ordering details

Voltage V	Accuracy Class	I/O	Communi- cation	Type	Order Code	Pkg qty	Weight 1 pc
Steel							
Active energy							
1 x 230 V AC	Class B (Cl. 1)	Pulse output	-	B21 111 - 100	2CMA100149R1000	1	0,14
			RS-485	B21 112 - 100	2CMA100150R1000	1	0,15
			M-Bus	B21 113 - 100	2CMA100151R1000	1	0,15
Bronze							
Active and reactive energy, import/export.							
1 x 230 V AC	Class B (Cl. 1) Reactive Cl. 2	Pulse output	RS-485	B21 212 - 100	2CMA100152R1000	1	0,15
Silver							
Active and reactive energy, import/export, tariffs 1-4, tariff control via inputs and communication.							
1 x 230 V AC	Class B (Cl. 1) Reactive Cl. 2	2 output, 2 input	-	B21 311 - 100	2CMA100154R1000	1	0,14
			RS-485	B21 312 - 100	2CMA100155R1000	1	0,15
			M-Bus	B21 313 - 100	2CMA100156R1000	1	0,15

Dimensions

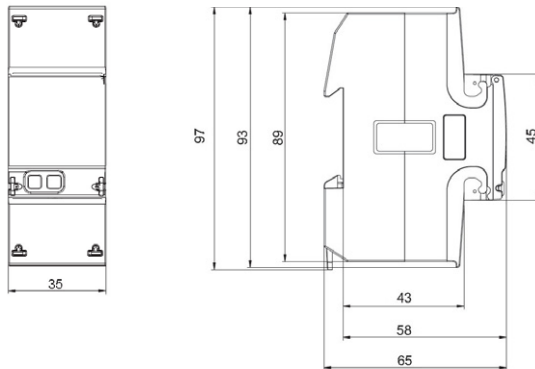

B23

Three phase meter

65A, 4 DIN with IR port



B23

Description

Direct connected electricity meter. Verified and approved according to MID. IEC approval. 2- and 3-element metering. Instrument values. Alarm function. Communication - Infrared (M-Bus). Optional - Communication with M-Bus, RS-485 Modbus, RS-485 EQ bus.

Ordering details

Voltage V	Accuracy Class	I/O	Communication	Type	Order Code	Pkg qty	Weight 1 pc
Steel							
Active energy							
3 x 230/400 V AC	Class B (Cl. 1)	Pulse output	-	B23 111 - 100	2CMA100163R1000	1	0.31
			RS-485	B23 112 - 100	2CMA100164R1000	1	0.32
			M-Bus	B23 113 - 100	2CMA100165R1000	1	0.33
Bronze							
Active and reactive energy, import/export.							
3 x 230/400 V AC	Class B (Cl. 1) Reactive Cl. 2	Pulse output	RS-485	B23 212 - 100	2CMA100166R1000	1	0.32
Silver							
Active and reactive energy, import/export, tariffs 1-4, tariff control via inputs and communication.							
3 x 230/400 V AC	Class B (Cl. 1) Reactive Cl. 2	2 output, 2 input	-	B23 311 - 100	2CMA100168R1000	1	0.33
			RS-485	B23 312 - 100	2CMA100169R1000	1	0.34
			M-Bus	B23 313 - 100	2CMA100170R1000	1	0.35

Dimensions

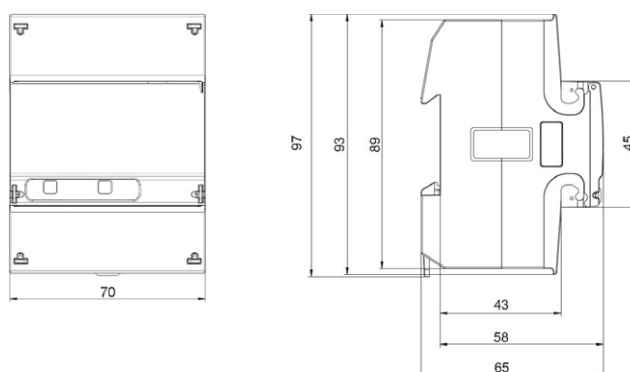

B24

Three phase meter 6A, 4 DIN with IR port

3



B24

Description

Transformer CT connected electricity meter. Verified and approved according to MID. IEC approval. 2- and 3-element metering. Instrument values. Alarm function. Communication - Infrared (M-Bus). Optional - Communication with M-Bus, RS-485 Modbus, RS-485 EQ bus.

Ordering details

Voltage V	Accuracy Class	I/O	Communication	Type	Order Code	Pkg qty	Weight 1 pc
Steel							
Active energy							
3 x 230/400 V AC	Class B (Cl. 1)	Pulse output	-	B24 111 - 100	2CMA100177R1000	1	0.25
			RS-485	B24 112 - 100	2CMA100178R1000	1	0.25
			M-Bus	B24 113 - 100	2CMA100179R1000	1	0.27
Bronze							
Active and reactive energy, import/export.							
3 x 230/400 V AC	Class B (Cl. 1) Reactive Cl. 2	Pulse output	RS-485	B24 212 - 100	2CMA100180R1000	1	0.25
Silver							
Active and reactive energy, import/export, tariffs 1-4, tariff control via inputs and communication.							
3 x 230/400 V AC	Class C (Cl. 0,5 S) Reactive Cl. 2	2 output, 2 input	-	B24 351 - 100	2CMA100182R1000	1	0.27
			RS-485	B24 352 - 100	2CMA100183R1000	1	0.27
			M-Bus	B24 353 - 100	2CMA100184R1000	1	0.29

Dimensions

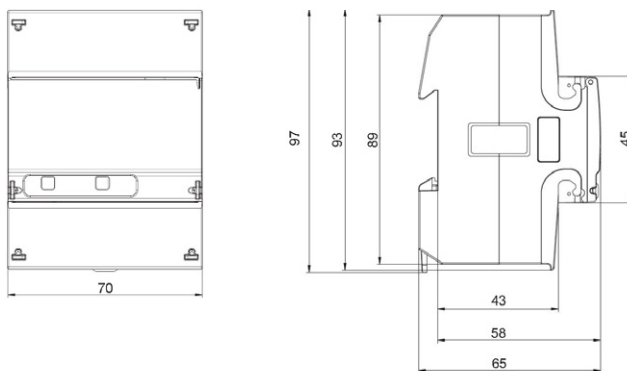

B series

Technical data

3

	B21	B23	B24
Voltage/current inputs			
Nominal voltage	230 V AC	3x230/400 V AC	
Voltage range	220-240 VAC (-20% - +15%)	3x220-240 VAC (-20% - +15%)	
Power dissipation voltage circuits	0.9 VA (0,4 W) total	1.6 VA (0,7 W) total	
Power dissipation current circuits	0.014 VA (0.014 W) at 230 V AC and I_b	0.007 VA (0.007 W) per phase at 230 V AC and I_b	
Base current I_b	5 A		
Rated current I_n	-		1 A
Reference current I_{ref}	5 A		-
Transitional current I_T	0.5 A		0.05 A
Maximum current I_{max}	65 A		6 A
Minimum current I_{min}	0.25 A		0.02 A
Starting current I_{st}	< 20 mA		< 1 mA
Terminal wire area	1 - 25 mm ²		0.5 - 10 mm ²
Recommended tightening torque	3 Nm		1.5 Nm
Communication			
Terminal wire area	0.5 - 1 mm ²		
Recommended tightening torque	0.25 Nm		
Transformer ratios			
Configurable current ratio (CT)	-		1/9 - 9999/1
Pulse indicator (LED)			
Pulse frequency	1000 imp/kWh	1000 imp/kWh	5000 imp/kWh
Pulse length	40 ms	40 ms	40 ms
General data			
Frequency	50 or 60 Hz ± 5%		
Accuracy Class	B (Cl. 1) and Reactive Cl. 2	B (Cl. 1) and Reactive Cl. 2	B (Cl. 1) or C (Cl. 0,5 S) and Reactive Cl. 2
Active energy	1%	1%	0.5%, 1%
Display of energy	6 digit LCD	7 digit LCD	
Environmental			
Operating temperature	-40°C - +70°C		
Storage temperature	-40°C - +85°C		
Humidity	75% yearly average, 95% on 30 days/year		
Resistance to fire and heat	Terminal 960 °C, cover 650°C (IEC 60695-2-1)		
Resistance to water and dust	IP20 on terminal block without protective enclosure and IP51 in protective enclosure, according to IEC 60529.		
Mechanical environment	Class M1 in accordance with the Measuring Instrument Directive (MID), (2004/22/EC).		
Electromagnetic environment	Class E2 in accordance with the Measuring Instrument Directive (MID), (2004/22/EC).		
Outputs			
Current	2 - 100 mA		
Voltage	5 - 240 V AC/DC. For meters with only 1 output 5 - 40 VDC.		
Pulse output frequency	Programmable: 1 - 999999 imp/kWh		
Pulse length	Programmable: 10 - 990 ms		
Terminal wire area	0.5 - 1 mm ²		
Recommended tightening torque	0.25 Nm		
Inputs			
Voltage	0 - 240 V AC/DC		
OFF	0 - 12 V AC/DC		
ON	57 - 240 V AC/24 - 240 V DC		
Min. pulse length	30 ms		
Terminal wire area	0.5 - 1 mm ²		
Recommended tightening torque	0.25 Nm		
EMC compatibility			
Impulse voltage test	6 kV 1.2/50µs (IEC 60060-1)		
Surge voltage test	4 kV 1.2/50µs (IEC 61000-4-5)		
Fast transient burn test	4kV (IEC 61000-4-4)		
Immunity to electromagnetic HF-fields	80 MHz - 2 GHz (IEC 61000-4-6)		
Immunity to conducted disturbance	150kHz - 80MHz (IEC 61000-4-6)		
Immunity to disturbance with harmonics	2kHz - 150kHz		
Radio frequency emission	EN 55022, class B (CISPR22)		
Electrostatic discharge	15 kV (IEC 61000-4-2)		
Standards	IEC 62052-11, IEC 62053-21 class 1 & 2, IEC 62053-22 class 0,5 S, IEC 62053-23 class 2, IEC 62054-21, GB/T 17215.211-2006, GB/T 17215.312-2008 class 1 & 2, GB/T 17215.322-2008 class 0,5 S, GB 4208-2008, EN 50470-1, EN 50470-3 category A, B & C		
Mechanical			
Material	Polycarbonate in transparent front glass. Glass reinforced polycarbonate in bottom case and upper case. Polycarbonate in terminal cover.		
Dimensions			
Width	35 mm	70 mm	
Height	97 mm	97 mm	
Depth	65 mm	65 mm	
DIN modules	2	4	

B series Wiring diagram

3

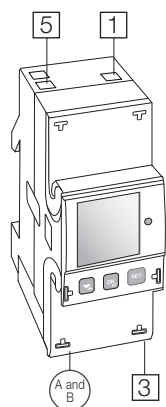

- 1 Phase in
- 3 Phase out
- 5 Neutral

Terminal blocks

B21

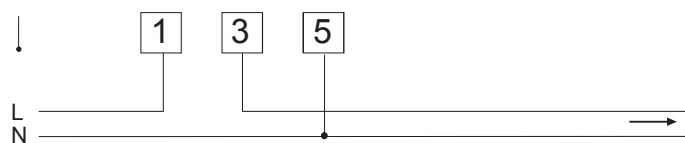

B23

3 wire connection, 2 elements

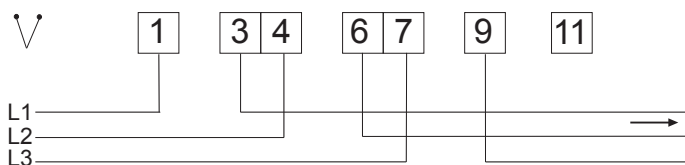

4 wire connection, 3 elements

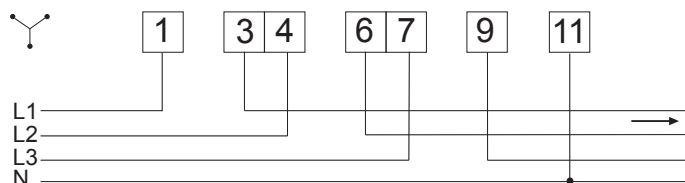

B24

3 wire connection, 2 elements

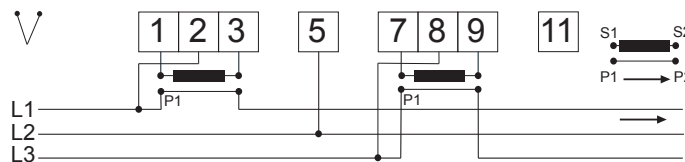

4 wire connection, 3 elements

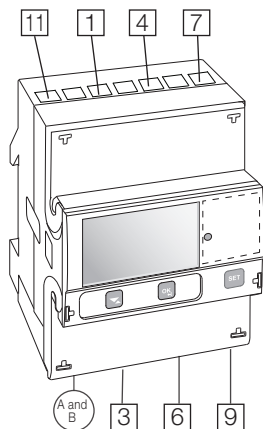
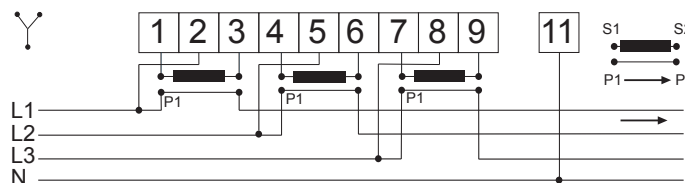

- 1 4 7 Phase in
- 3 6 9 Phase out
- 11 Neutral

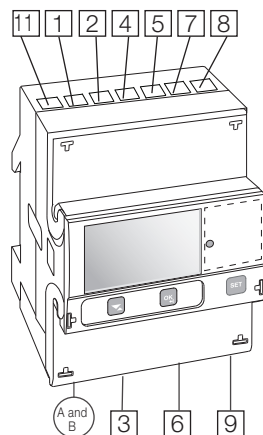

- 1 4 7 Current in
- 2 5 8 Voltage
- 3 6 9 Current out
- 11 Neutral

B series

Inputs/outputs and communication

Inputs/Outputs (A) = Please see the pictures on page 28

2 outputs, 2 inputs

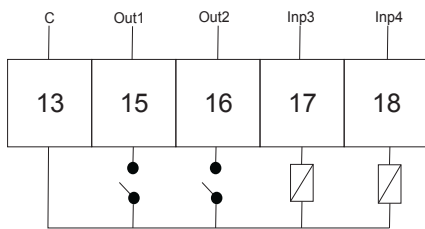

1 output

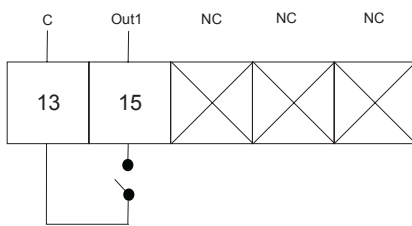

Communication (B) = Please see the pictures on page 28

RS-485

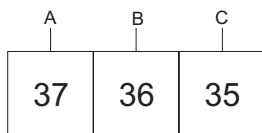

M-Bus

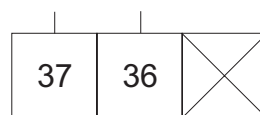

C series

Product brief

4



Key applications

- Landlord sub-metering
- Object metering

Meter performance

- Direct connected up to 40 A
- Active energy
- Low power consumption
- Alarm function

Communication

- Pulse output

Installation

- Small size - 1 DIN (single phase) or 3 DIN (three phase) modules width
- Wide temperature range
- Easy configuration

Approvals

- MID type approval "annex B"
- MID initial verification "annex F"
- IEC type approval

C series

Description



The EQ meters, C series are truly compact meters for single phase and three phase metering. The C series is mounted on a DIN rail and is suitable for installation in distribution boards and small consumer units.

General features

Only one module wide, the C series is a very compact meter for single phase and three phase applications. The meters have an LCD with large digits showing energy register and instrumentation values. The meters have a wide temperature range which makes it possible to install the meters in many locations. Navigating the meters are easily done via the push-button below the display.

Instrumentation

The C series meters support reading of instrument values. A number of electrical properties can be read:

- Power factor
- Active power
- Current
- Voltage

Outputs

The C series meters have an output that can be used as pulse output or alarm output. The alarm quantity and levels is easily configured on the meter with the push button. The output can be used for controlling external apparatus like a contactor or an alarm indicator (connected via an external relay).

Approvals

The C series meters are type approved according to IEC and MID. MID is the Measuring Instruments Directive 2004/22/EC from the European Commission. The type approval is according to standards that covers all relevant technical aspects of the meter. These include climate conditions, electromagnetic compatibility (EMC), electrical requirements, mechanical requirements and accuracy.

MID versions have initial verification according to annex F of the Measuring Instruments Directive.

C11 and C13

Single and three phase meter

40A

4



C11

Description C11

Direct connected electricity meter. IEC approval. Instrument values. Alarm function. Optional - Verified and approved according to MID, 1 DIN.

Ordering details

Voltage V	Accuracy Class	I/O	Communi-cation	Type	Order Code	Pkg qty	Weight 1 pc
Steel							
Active energy							
1 x 230 V AC	Class B (Cl. 1)	Pulse output	-	C11 110 - 100 ^{*)}	2CMA100014R1000	1	0.07
	Class 1			C11 110 - 300	2CMA170550R1000	1	0.07

^{*)} MID approval



C13

Description C13

Direct connected electricity meter. IEC approval. 3 element metering. Instrument values. Alarm function. Optional - Verified and approved according to MID, 3DIN.

Ordering details

Voltage V	Accuracy Class	I/O	Communi-cation	Type	Order Code	Pkg qty	Weight 1 pc
Steel							
Active energy							
3 x 230/400 V AC	Class B (Cl. 1)	Pulse output	-	C13 110 - 100 ^{*)}	2CMA100191R1000	1	0.17
	Class 1			C13 110 - 300	2CMA100192R1000	1	0.17

^{*)} MID approval

Dimensions

C11

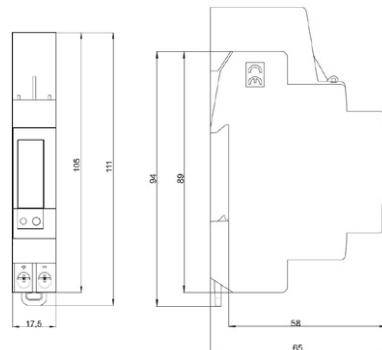

C13

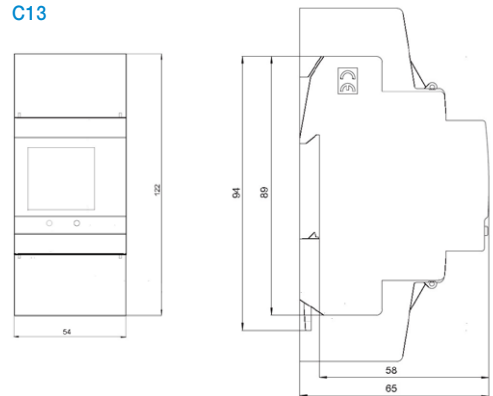

C series

Technical data

	C11	C13
Voltage/current inputs		
Nominal voltage	230 V AC	3x230/400
Voltage range	230 V AC (-20% - +15%)	3x220-240 V AC (-20% - +15%)
Power dissipation voltage circuits	< 0.8 VA (0.2 W) total	1.5 VA (0.6 W) total
Power dissipation current circuits	0.02 W at 230 V AC and I_b	0.04 VA (0.04 W) per phase at 230 V AC and I_b
Base current I_b	5 A	
Rated current I_n	-	
Reference current I_{ref}	5 A	
Transitional current I_{tr}	0.5 A	
Maximum current I_{max}	40 A	
Minimum current I_{min}	0.25 A	
Starting current I_{st}	< 20 mA	
Terminal wire area	1 - 10 mm ²	0.5 - 10 mm ²
Recommended tightening torque	0,8 Nm	
General data		
Frequency	50 or 60 Hz ± 5%	
Accuracy Class	B (Cl.1)	
Active energy	1%	
Display of energy	6 digits LCD	
Communication		
Terminal wire area	-	
Recommended tightening torque	-	
Pulse indicator (LED)		
Pulse frequency	1000 imp/kWh	
Pulse length	40 ms	
Environmental		
Operating temperature	- 25°C - +70°C	
Storage temperature	- 25°C - +85°C	
Humidity	75% yearly average, 95% on 30 days/year	
Resistance to fire and heat	Terminal 960°C, cover 650°C (IEC 60695-2-1)	
Resistance to water and dust	IP20 on terminal block without protective enclosure and IP51 in protective enclosure, according to IEC 60529.	
Mechanical environment	Class M1 in accordance with the Measuring Instrument Directive (MID), (2004/22/EC).	
Electromagnetic environment	Class E2 in accordance with the Measuring Instrument Directive (MID), (2004/22/EC).	
Outputs		
Current	2 - 100 mA	
Voltage	5 - 40 V DC	
Pulse output frequency	100 (imp/kWh)	
Pulse length	200 ms	
Terminal wire area	0.5 - 6 mm ²	
Recommended tightening torque	0.8 Nm	
EMC compatibility		
Impulse voltage test	6 kV 1.2/50 µs (IEC 60060-1)	
Surge voltage test	4 kV 1.2/50 µs (IEC 61000-4-5)	
Fast transient burn test	4 kV (IEC 61000-4-4)	
Immunity to electromagnetic HF-fields	80 MHz - 2 GHz at 10 V/m (IEC 61000-4-3)	
Immunity to conducted disturbance	150 kHz - 80 MHz, (IEC 61000-4-6)	
Immunity to disturbance with harmonics	2kHz - 150kHz	
Radio frequency emission	EN 55022, class B (CISPR22)	
Electrostatic discharge	15 kV (IEC 61000-4-2)	
Standards	IEC 62052-11, IEC 62053-21 class 1, GB/T 17215.211-2006, GBT 17215.321-2008 class 1, GB 4208-2008, EN 50470-1, EN 50470-3 category B	
Mechanical		
Material	Glass reinforced polycarbonate	
Dimensions		
Width	17,5 mm	54 mm
Height	111 mm	122 mm
Depth	65 mm	65 mm
DIN modules	1	3

C series

Wiring diagrams

4

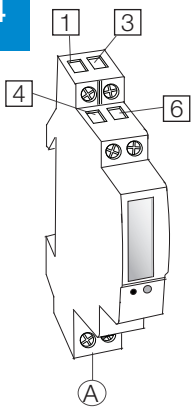

- 1 Phase in
- 3 Phase out
- 4 6 Neutral

Terminal blocks

C11

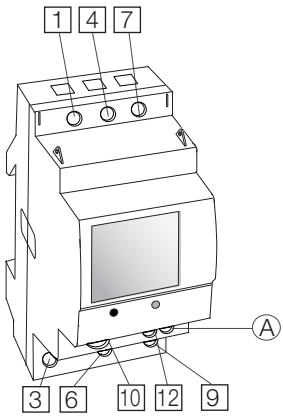
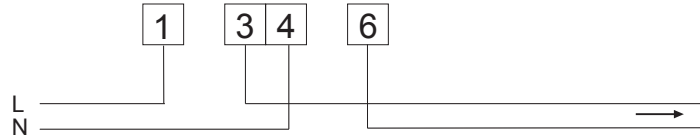

- 1 4 7 Phase in
- 3 6 9 Phase out
- 10 12 Neutral

C13

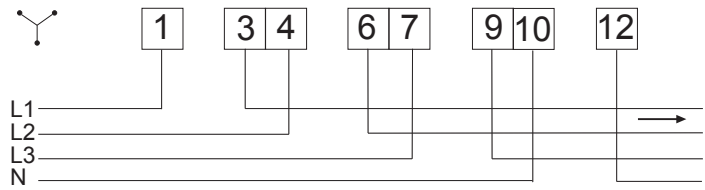

Output (A) = Please see the pictures on the left

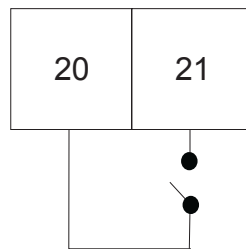

Accessories

Ordering data



Front mounting kit

2CMC480005FR032



Enclosure

2CMC484003FR056

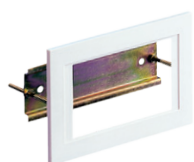

ME

2CMC481049FR001

Accessories for electricity energy meters

Application	Type	Order code	Pkg qty	Weight 1(pce) kg
Front mounting kit				
Panel mounting	Front mounting kit	2CMA132635R1000	1	0.200

Enclosure				
Wall mounting	Enclosure IP51 (6 modules)	2CMA131022R1000	1	0.500

Application	EAN code	Type	Order code	Pkg qty	Weight 1(pce) kg
Flanges					
Flange for rear board fixing 1 module - IP40	8012542304401	ME1	16219000	1	0.040
Flange for rear board fixing 2 modules - IP40	8012542304500	ME2	16219018	1	0.045
Flange for rear board fixing 3 module - IP40	8012542304609	ME3	16219026	1	0.055
Flange for rear board fixing 4 module - IP40	8012542304708	ME4	16219004	1	0.060
Flange for rear board fixing 6 module - IP40	8012542304807	ME6	16219004	1	0.070
Flange for rear board fixing 8 module - IP40	8012542304807	ME8	16219059	1	0.090

Find more accessories, power supplies, timers and other useful Modular Din Rail Components (MDRC's) in the System pro M compact® catalogue 2CSC400002D0211 or on www.abb.com/lowvoltage.

Communication products

Description

5

G13 is the new Ethernet gateway that will make data collection from a meter network very convenient. Communication is performed using JSON (JavaScript Object Notation) on the Ethernet side. The gateway is also equipped with a webserver that provides a detailed overview of all meters installed in a network as well as the possibility to perform advanced configurations of the meters and read-out data. High data security is obtained by encryption using SSL (Secure Sockets Layer).



The gateway communicates with EQ meters over EQ bus, a communication protocol based on the IEC standards (DLMS/cosem), using RS-485, and can also work as an M-Bus master for M-Bus enabled ABB meters.

The KNX Meter Interface Module ZS/S enables remote reading of meter data and meter values from ABB energy meters from the A series.

The information that is read can be used, for example, for cost-center accounting, energy optimization, and visualization or monitoring of installations. Furthermore, meter functions such as tariff switching, for example, can be controlled via KNX, depending on the meter type used.

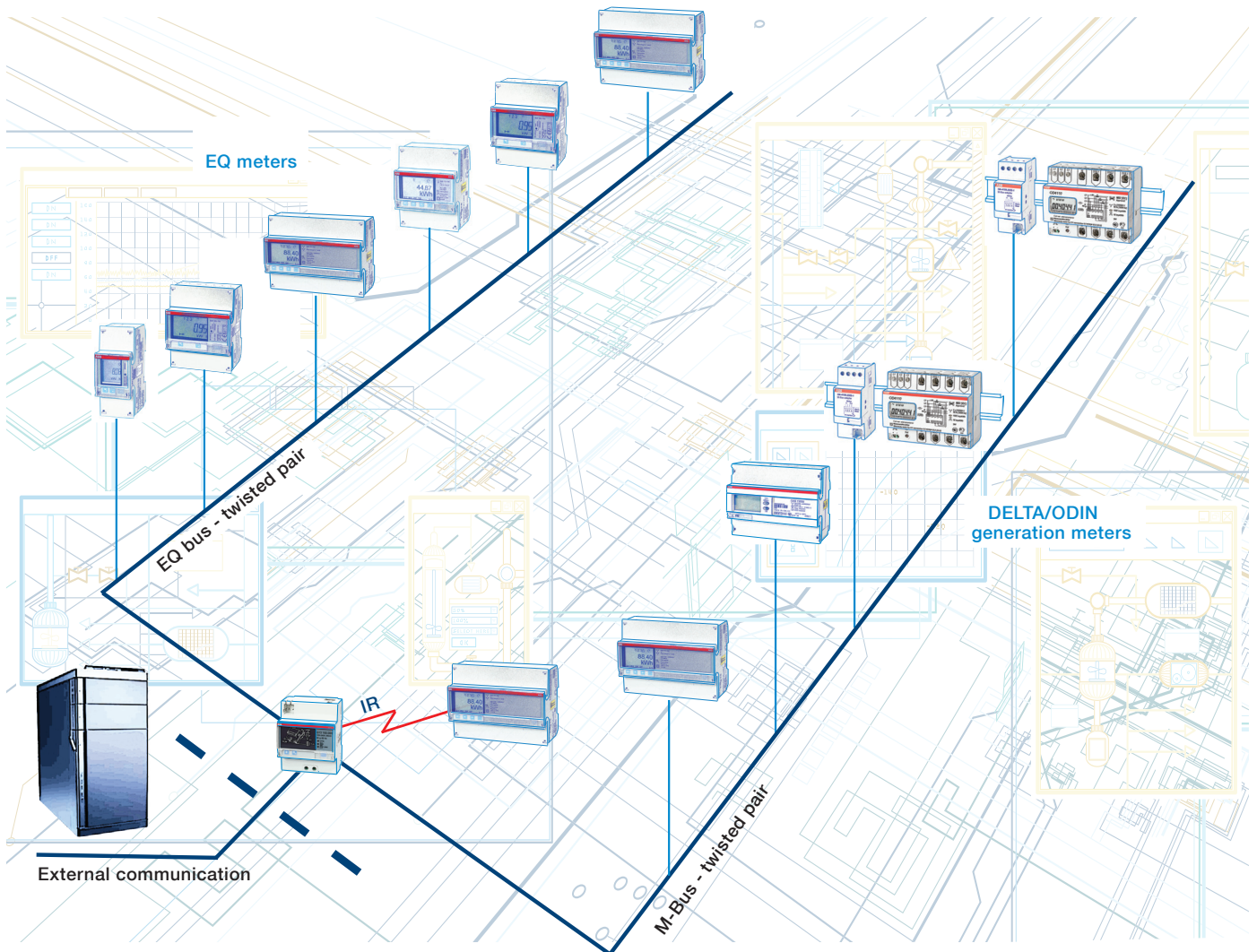



G13



KNX

Description

Gateway G13 100-000

Gateway for routing and protocol conversion between system and meter network with up to 32 meters
 Communication protocols on the meter side: EQ bus over RS-485, M-Bus and ABB IR port
 Communication protocols on the system side: Ethernet with JSON. Built-in webserver for meter reading and meter management

KNX Meter Interface Module ZS/S1.1

Module to interface meters with ABB IR port to a KNX network. Support EQ meters A series, DELTAplus, DELTAsingle, ODIN and ODINSingle.

Ordering details

Voltage V	Description	Type	Order Code	Pkg qty	Weight 1 pc
100 - 240 V AC	Ethernet Gateway ¹⁾	G13 100-000	2CMA170552R1000	1	0.19
Powered by bus	KNX Meter interface module ²⁾	ZS/S1.1	2CDG110083R1000	1	0.07

¹⁾ For technical information, please see manual 2CMC489001M0201.

²⁾ For technical information, please visit www.abb.com/knx or read 2CDC 500 098 C0201 Smart Home and Intelligent Building Control Product Range Overview 2013.

Dimensions G13

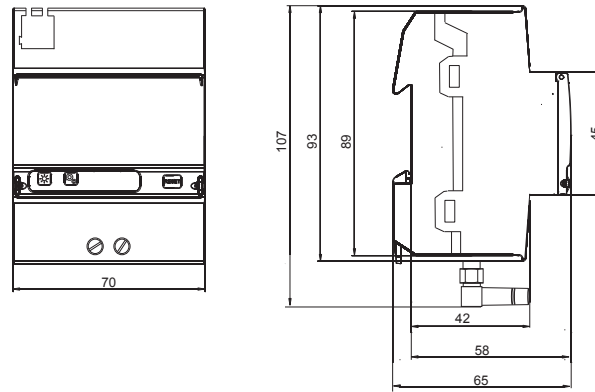

Dimensions ZS/S1.1

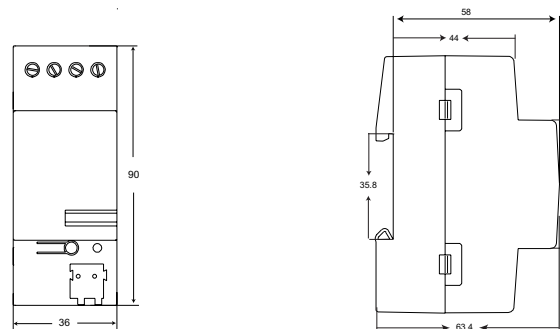

Cross reference

Meter type - Order code

6

Type	Order code	Page
A41 111 - 100	2CMA170554R1000	15
A41 112 - 100	2CMA170500R1000	15
A41 113 - 100	2CMA100240R1000	15
A41 212 - 100	2CMA170501R1000	15
A41 311 - 100	2CMA170502R1000	15
A41 312 - 100	2CMA170503R1000	15
A41 313 - 100	2CMA170504R1000	15
A41 412 - 100	2CMA170505R1000	15
A41 413 - 100	2CMA170506R1000	15
A41 512 - 100	2CMA100237R1000	15
A41 513 - 100	2CMA170508R1000	15
A42 111 - 100	2CMA170555R1000	16
A42 112 - 100	2CMA170510R1000	16
A42 113 - 100	2CMA100242R1000	16
A42 212 - 100	2CMA170511R1000	16
A42 312 - 100	2CMA170512R1000	16
A42 412 - 100	2CMA170513R1000	16
A42 413 - 100	2CMA170514R1000	16
A42 552 - 100	2CMA100238R1000	16
A42 553 - 100	2CMA170516R1000	16
A43 111 - 100	2CMA170520R1000	17
A43 112 - 100	2CMA100244R1000	17
A43 113 - 100	2CMA100245R1000	17
A43 121 - 100	2CMA170521R1000	17
A43 211 - 100	2CMA100012R1000	17
A43 212 - 100	2CMA170522R1000	17
A43 213 - 100	2CMA170523R1000	17
A43 311 - 100	2CMA170524R1000	17
A43 312 - 100	2CMA170525R1000	17
A43 313 - 100	2CMA170526R1000	17
A43 412 - 100	2CMA170528R1000	17
A43 413 - 100	2CMA170529R1000	17
A43 511 - 100	2CMA100143R1000	17
A43 512 - 100	2CMA170531R1000	17
A43 513 - 100	2CMA170532R1000	17
A44 111 - 100	2CMA170533R1000	18
A44 112 - 100	2CMA100248R1000	18
A44 113 - 100	2CMA100249R1000	18
A44 211 - 100	2CMA100013R1000	18
A44 212 - 100	2CMA170534R1000	18
A44 213 - 100	2CMA170535R1000	18
A44 311 - 100	2CMA170536R1000	18

Type	Order code	Page
A44 352 - 100	2CMA170537R1000	18
A44 353 - 100	2CMA170538R1000	18
A44 452 - 100	2CMA170540R1000	18
A44 453 - 100	2CMA170541R1000	18
A44 552 - 100	2CMA170545R1000	18
A44 553 - 100	2CMA170546R1000	18
B21 111 - 100	2CMA100149R1000	24
B21 112 - 100	2CMA100150R1000	24
B21 113 - 100	2CMA100151R1000	24
B21 212 - 100	2CMA100152R1000	24
B21 311 - 100	2CMA100154R1000	24
B21 312 - 100	2CMA100155R1000	24
B21 313 - 100	2CMA100156R1000	24
B23 111 - 100	2CMA100163R1000	25
B23 112 - 100	2CMA100164R1000	25
B23 113 - 100	2CMA100165R1000	25
B23 212 - 100	2CMA100166R1000	25
B23 311 - 100	2CMA100168R1000	25
B23 312 - 100	2CMA100169R1000	25
B23 313 - 100	2CMA100170R1000	25
B24 111 - 100	2CMA100177R1000	26
B24 112 - 100	2CMA100178R1000	26
B24 113 - 100	2CMA100179R1000	26
B24 212 - 100	2CMA100180R1000	26
B24 351 - 100	2CMA100182R1000	26
B24 352 - 100	2CMA100183R1000	26
B24 353 - 100	2CMA100184R1000	26
C11 110 - 100	2CMA100014R1000	32
C11 110 - 300	2CMA170550R1000	32
C13 110 - 100	2CMA100191R1000	33
C13 110 - 300	2CMA100192R1000	33
Enclosure	2CMA131022R1000	38
Front mounting kit	2CMA132635R1000	38
G13 100-000	2CMA170552R1000	37
ME1	16219000	38
ME2	16219018	38
ME3	16219026	38
ME4	16219004	38
ME6	16219004	38
ME8	16219059	38
ZS/S1.1	2CDG110083R1000	37

Cross reference

Order code - Meter type

Order code	Type	Page
16219000	ME1	38
16219004	ME4	38
16219004	ME6	38
16219018	ME2	38
16219026	ME3	38
16219059	ME8	38
2CDG110083R1000	ZS/S1.1	37
2CMA100012R1000	A43 211 - 100	17
2CMA100013R1000	A44 211 - 100	18
2CMA100014R1000	C11 110 - 100	32
2CMA100143R1000	A43 511 - 100	17
2CMA100149R1000	B21 111 - 100	24
2CMA100150R1000	B21 112 - 100	24
2CMA100151R1000	B21 113 - 100	24
2CMA100152R1000	B21 212 - 100	24
2CMA100154R1000	B21 311 - 100	24
2CMA100155R1000	B21 312 - 100	24
2CMA100156R1000	B21 313 - 100	24
2CMA100163R1000	B23 111 - 100	25
2CMA100164R1000	B23 112 - 100	25
2CMA100165R1000	B23 113 - 100	25
2CMA100166R1000	B23 212 - 100	25
2CMA100168R1000	B23 311 - 100	25
2CMA100169R1000	B23 312 - 100	25
2CMA100170R1000	B23 313 - 100	25
2CMA100177R1000	B24 111 - 100	26
2CMA100178R1000	B24 112 - 100	26
2CMA100179R1000	B24 113 - 100	26
2CMA100180R1000	B24 212 - 100	26
2CMA100182R1000	B24 351 - 100	26
2CMA100183R1000	B24 352 - 100	26
2CMA100184R1000	B24 353 - 100	26
2CMA100191R1000	C13 110 - 100	33
2CMA100192R1000	C13 110 - 300	33
2CMA100237R1000	A41 512 - 100	15
2CMA100238R1000	A42 552 - 100	16
2CMA100240R1000	A41 113 - 100	15
2CMA100242R1000	A42 113 - 100	16
2CMA100244R1000	A43 112 - 100	17
2CMA100245R1000	A43 113 - 100	17
2CMA100248R1000	A44 112 - 100	18
2CMA100249R1000	A44 113 - 100	18

Order code	Type	Page
2CMA131022R1000	Enclosure	38
2CMA132635R1000	Front mounting kit	38
2CMA170500R1000	A41 112 - 100	15
2CMA170501R1000	A41 212 - 100	15
2CMA170502R1000	A41 311 - 100	15
2CMA170503R1000	A41 312 - 100	15
2CMA170504R1000	A41 313 - 100	15
2CMA170505R1000	A41 412 - 100	15
2CMA170506R1000	A41 413 - 100	15
2CMA170508R1000	A41 513 - 100	15
2CMA170510R1000	A42 112 - 100	16
2CMA170511R1000	A42 212 - 100	16
2CMA170512R1000	A42 312 - 100	16
2CMA170513R1000	A42 412 - 100	16
2CMA170514R1000	A42 413 - 100	16
2CMA170516R1000	A42 553 - 100	16
2CMA170520R1000	A43 111 - 100	17
2CMA170521R1000	A43 121 - 100	17
2CMA170522R1000	A43 212 - 100	17
2CMA170523R1000	A43 213 - 100	17
2CMA170524R1000	A43 311 - 100	17
2CMA170525R1000	A43 312 - 100	17
2CMA170526R1000	A43 313 - 100	17
2CMA170528R1000	A43 412 - 100	17
2CMA170529R1000	A43 413 - 100	17
2CMA170531R1000	A43 512 - 100	17
2CMA170532R1000	A43 513 - 100	17
2CMA170533R1000	A44 111 - 100	18
2CMA170534R1000	A44 212 - 100	18
2CMA170535R1000	A44 213 - 100	18
2CMA170536R1000	A44 311 - 100	18
2CMA170537R1000	A44 352 - 100	18
2CMA170538R1000	A44 353 - 100	18
2CMA170540R1000	A44 452 - 100	18
2CMA170541R1000	A44 453 - 100	18
2CMA170545R1000	A44 552 - 100	18
2CMA170546R1000	A44 553 - 100	18
2CMA170550R1000	C11 110 - 300	32
2CMA170552R1000	G13 100-000	37
2CMA170554R1000	A41 111 - 100	15
2CMA170555R1000	A42 111 - 100	16

Contact us

ABB AB

Meters

Box 1005

SE-611 29 NYKÖPING, Sweden

Telephone +46 155 29 50 00

Telefax +46 155 28 81 10

www.abb.com

© Copyright 2013 ABB. All rights reserved.
Specification subject to change without notice.



This QR-code is linked to our web site
www.abb.com/lowvoltage.
You will have to download a QR-code reader
app to your phone in order to use it.



This QR-code is linked to the latest version
of our catalog in PDF format.
You will have to download a QR-code reader
app to your phone in order to use it.

